

## Relief Modular Valves

### Specifications

Model Numbers	Max. Operating Pressure MPa (PSI)	Max. Flow L/min (U.S.GPM)
MBP-03-*-30 MBA-03-*-30 MBB-03-*-30 MBW-03-*-30	31.5 (4570)	70 (18.5)

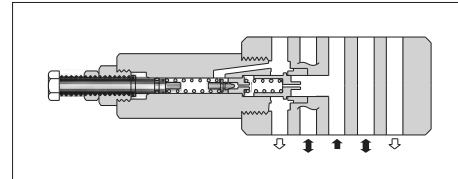

### Model Number Designation

<b>F-</b>	<b>MBA</b>	<b>-03</b>	<b>-B</b>	<b>-30</b>	<b>*</b>
Special Seals	Series Number	Valve Size	Pres. Adj. Range MPa (PSI)	Design Number	Design Standard
<b>F:</b> Special Seals for Phosphate Ester Type Fluids (Omit if not required)	<b>MBP</b> : Relief Valve for P-Line <b>MBA</b> : Relief Valve for A-Line <b>MBB</b> : Relief Valve for B-Line <b>MBW</b> : Relief Valve for A&B-Lines	<b>03</b>	<b>B:</b> *-7 *1 (*-1020) <b>H:</b> 3.5-31.5 (510-4570)	<b>30</b>	Refer to ★ 2

★ 1. See the "Minimum Adjustment Pressure" of the next page for the item marked \*.

★ 2. Design Standards: None ..... Japanese Standard "JIS", European Design Standard and N. American Design Standard

### Instructions

- The minimum adjustment pressure equals the value obtained from the minimum adjustment pressure characteristics plus the tank line back pressure of the next page. This back pressure should include the value of the T-line pressure drop characteristics of the valves stacked to the base plate side of the modular valve.
- To make pressure adjustment, loosen the lock nut and turn the pressure adjustment screw clockwise or anti-clockwise. For an increase of pressure, turn the screw clockwise. Be sure to re-tighten the lock nut firmly after making adjustment to the pressure.
- In case of a small flow, the setting pressure may become unstable. To avoid this, refer to the minimum flow characteristic curve of the next page and use the valve within a range as shown with .

Model Numbers	Graphic Symbols	Detailed Graphic Symbols
MBP-03		
MBA-03		
MBB-03		
MBW-03		

## Typical Performance Characteristics

Hydraulic Fluid: Viscosity 35 mm<sup>2</sup>/s (164 SSU), Specific Gravity 0.850

### Nominal Override Characteristics

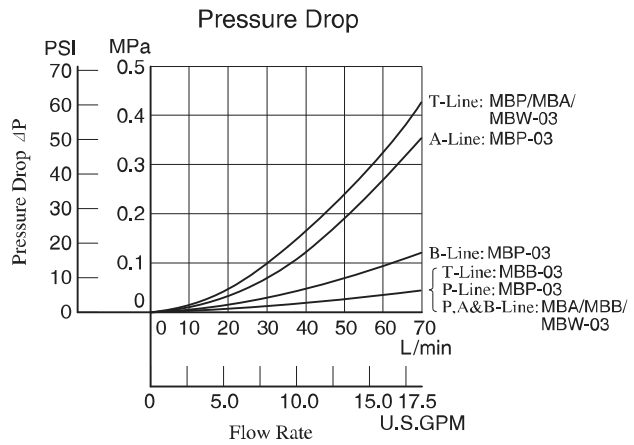
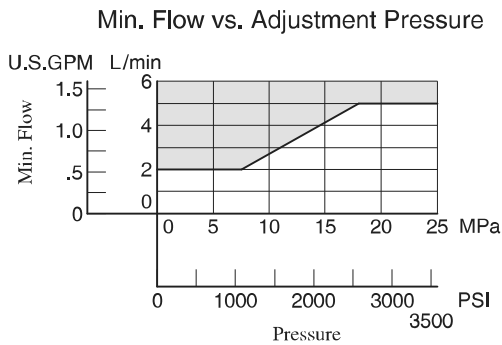
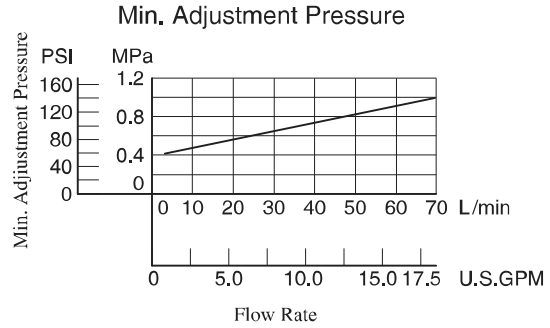
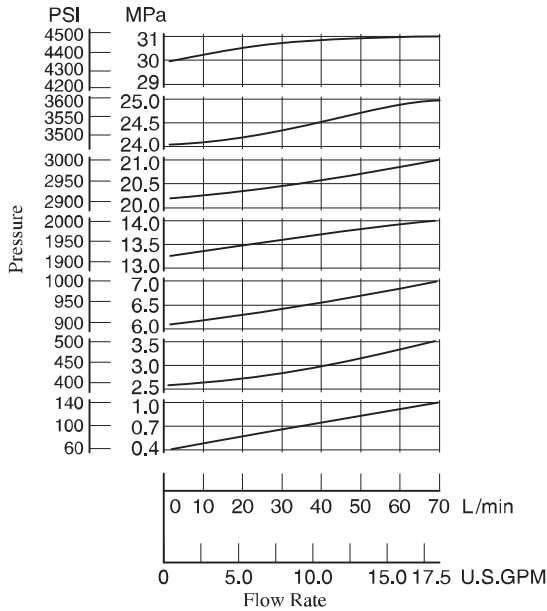

F

03 Series Modular Valves

**MBW-03-\*-30**

**DIMENSIONS IN MILLIMETRES (INCHES)**

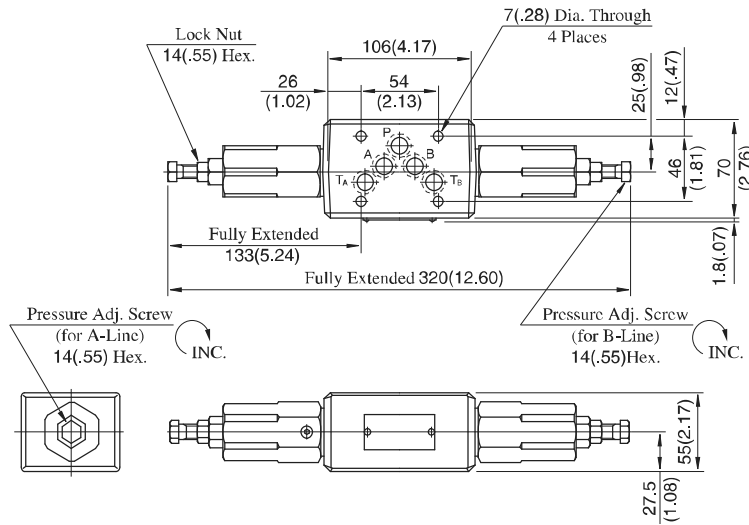

Approx. Mass.....3.8 kg (8.4 lbs.)

**MBP-03-\*-30  
MBA-03-\*-30**

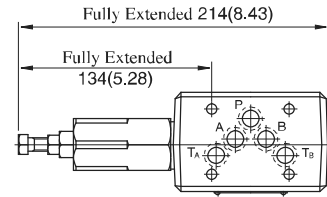

Approx. Mass.....3.1 kg (6.8 lbs.)

• For other dimensions, refer to "MBW-03" drawing left.

**MBB-03-\*-30**

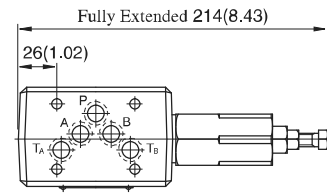

Approx. Mass.....3.1 kg (6.8 lbs.)

• For other dimensions, refer to "MBW-03" drawing left.

■ Spare Parts List

**MBP-03-\*-30  
MBA-03-\*-30**

**MBB-03-\*-30**

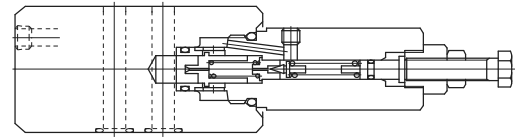
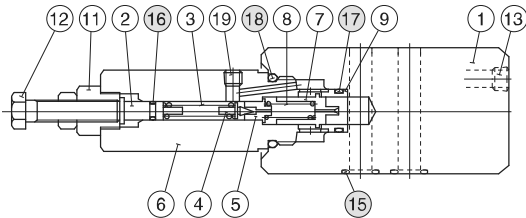

**MBW-03-\*-30**

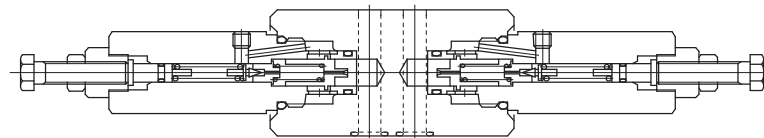

● List of Seals

Item	Name of Parts	Part Numbers	Quantity			
			MBP-03	MBA-03	MBB-03	MBW-03
15	O-Ring	SO-NB-A014	5	5	5	5
16	O-Ring	SO-NA-P6	1	1	1	2
17	O-Ring	SO-NB-P16	1	1	1	2
18	O-Ring	SO-NB-P26	1	1	1	2

Note: When ordering seals, please specify the seal kit number from the table right.

● List of Seal Kits

Valve Model Numbers	Seal kit Numbers
MBP-03	KS-MBP-03-30
MBA-03	
MBB-03	
MBW-03	KS-MBW-03-30