

Sequence Modular Valves/Counterbalance Modular Valves

Specifications

Model Numbers	Max. Operating Pressure MPa (PSI)	Max. Flow L/min (U.S.GPM)	Free Flow L/min (U.S.GPM)
MHP-01-*-30	25 (3630)	35 (9.25)	—
MHA-01-*-30			35 (9.25)

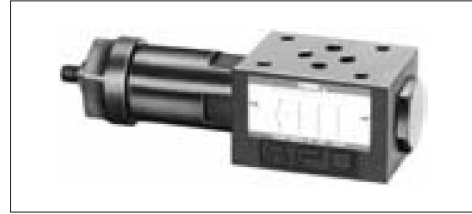

Graphic Symbols

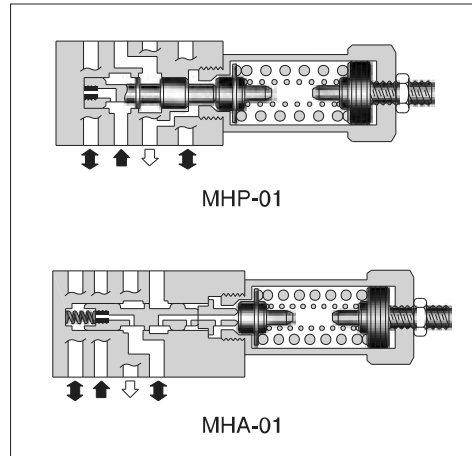
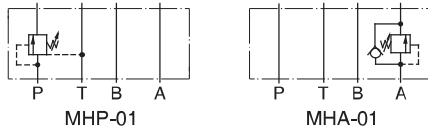

Model Number Designation

F-	MHP	-01	-C	-30	*
Special Seals	Series Number	Valve Size	Pres. Adj. Range MPa (PSI)	Design Number	Design Standard
F: Special Seals for Phosphate Ester Type Fluids (Omit if not required)	MHP: Sequence Valve for P-Line MHB: Counterbalance Valve for A-Line	01	C: *-14 *1 (*-2030) H: 7-21 (1020-3050)	30	Refer to ★ 2

★ 1. See the "Minimum Adjustment Pressure" of the next page for the item marked *.

★ 2. Design Standards: None Japanese Standard "JIS", European Design Standard and N. American Design Standard

Instructions

- The minimum adjustment pressure (MHP-01) equals the value obtained from the minimum adjustment pressure characteristics plus the tank line back pressure of the next page. This back pressure should include the value of the T-line pressure drop characteristics of the valves stacked to the base plate side of the modular valve.
- To make pressure adjustment, loosen the lock nut and turn the pressure adjustment screw clockwise or anti-clockwise. For an increase of pressure, turn the screw clockwise. Be sure to re-tighten the lock nut firmly after making adjustment to the pressure.
- The minimum adjustment pressure (MHA-01) equals the value obtained from the minimum adjustment pressure characteristics plus the outlet-side back pressure of the valve on the next page. The outlet-side back pressure should include the values of the A-line and T-line pressure drop characteristics of the valves to be stacked due to the valve with internal drain.

■ Typical Performance Characteristics

Hydraulic Fluid: Viscosity 35 mm²/s (164 SSU), Specific Gravity 0.850

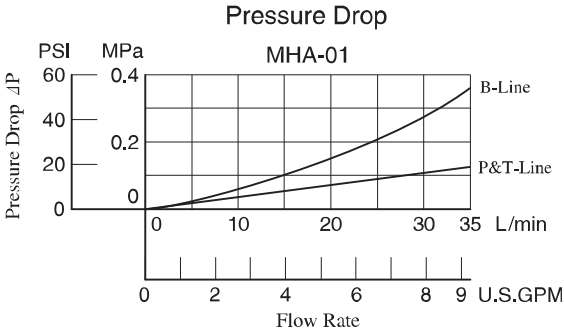
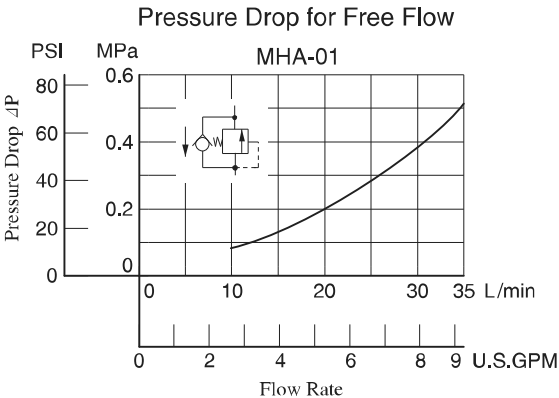
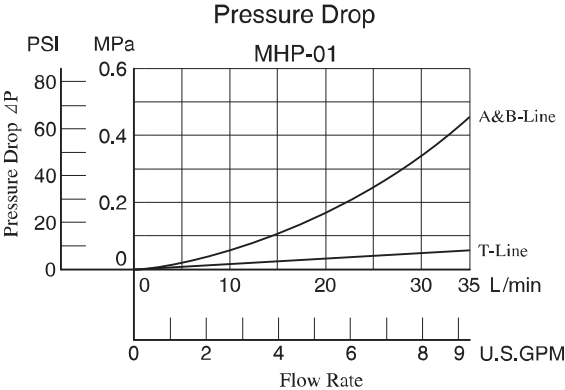
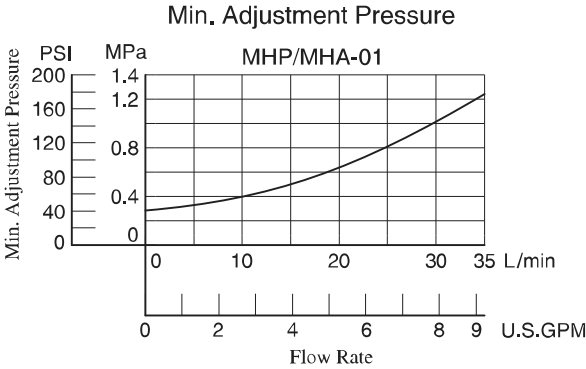

MHP-01-*-30

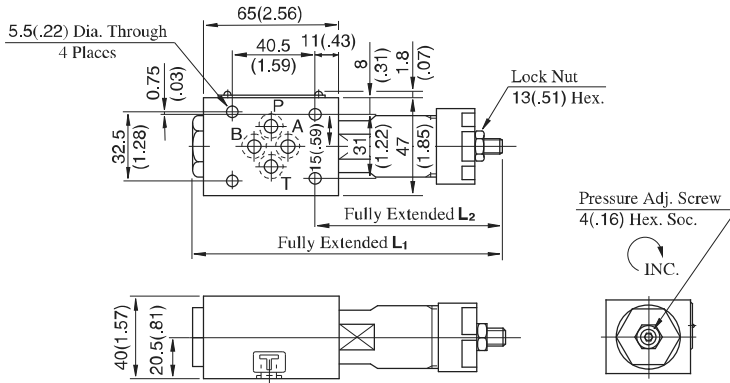

Model Numbers	L ₁	L ₂
MHP-01-C	151 (5.94)	92 (3.62)
MHP-01-H	166.5 (6.56)	107.5 (4.23)

Approx. Mass.....1.1 kg (2.4 lbs.)

DIMENSIONS IN MILLIMETRES (INCHES)

MHA-01-*-30

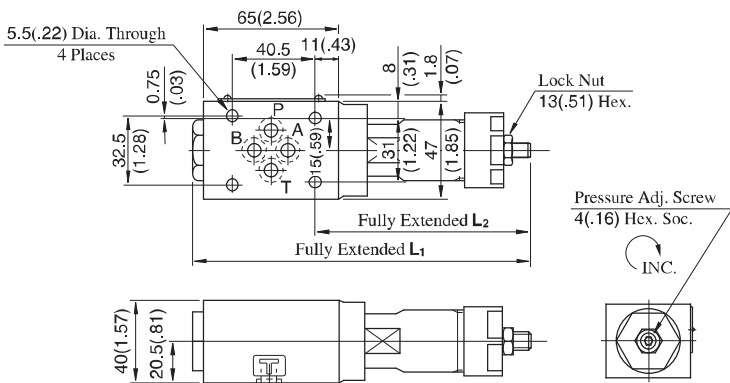

Model Numbers	L ₁	L ₂
MHA-01-C	171 (6.73)	112 (4.41)
MHA-01-H	186.5 (7.34)	127.5 (5.02)

Approx. Mass.....1.3 kg (2.9 lbs.)

■ Spare Parts List

MHP-01-*-30

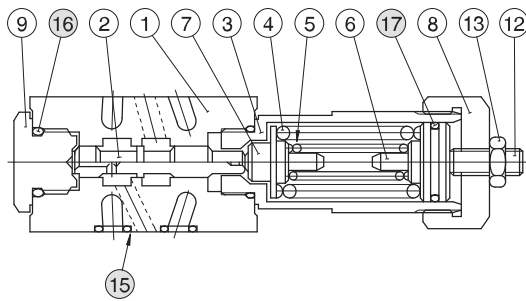

● List of Seals

Item	Name of Parts	Part Numbers	Qty.	Remarks
15	O-Ring	SO-NB-P9	4	Included in Seal Kit Kit No.: KS-MBP-01-30
16	O-Ring	SO-NB-P18	2	
17	O-Ring	SO-NA-P20	1	

MHA-01-*-30

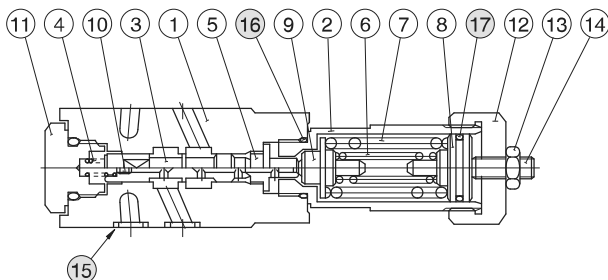

● List of Seals

Item	Name of Parts	Part Numbers	Qty.	Remarks
15	O-Ring	SO-NB-P9	4	Included in Seal Kit Kit No.: KS-MHA-01-30
16	O-Ring	SO-NB-P18	2	
17	O-Ring	SO-NB-P20	1	

Pressure Switch Modular Valves

Specifications

Model Numbers	Max. Operating Pressure MPa(PSI)	Max. Flow L/min (U.S.GPM)
MJ*-01-M-*-*-10	31.5 (4570)	35 (9.25)
MJ*-01-J-35-10	10 (1450)	
MJ*-01-J-100-10	10 (1450)	
MJ*-01-J-200-10	20 (2900)	
MJ*-01-J-350-10	35 (5080)	

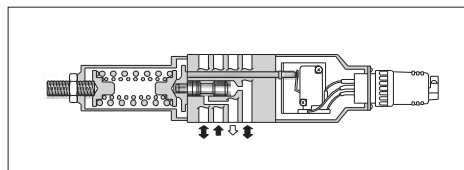

Sensitive Switch Ratings

Electric Source		AC	DC	
Voltage	V	125 · 250	125	250
Current	A	11A-1/3HP	0.5	0.25

Specifications of semiconductor type pressure switch

JT-02 series is installed for semiconductor type pressure switch, refer to page 272 for details.

Model Number Designation

F-	MJP	-01	-M	-B	-N	-10	*
Special Seals	Series Number	Valve Size	Type of Switch	Pres. Adj. Range MPa (PSI)	Type of Electrical Connection	Design Number	Design Standard
F: Special Seals for Phosphate Ester Type Fluids (Omit if not required)	MJP : Pressure Switch for P-Line MJA : Pressure Switch for A-Line MJB : Pressure Switch for B-Line	01	M: Sensitive Switch	B: 1-7 (145-1020) C: 3.5-14 (510-2030) H: 7-21 (1020-3050)	None: Cable Connector Type N: With Plug-in Connector (DIN)	10	Refer to ★
			J: Semiconductor Type Pressure Switch	35: 0.1-3.5 (14.5-510) 100: 1-10 (145-1450) 200: 2-20 (290-2900) 350: 3.5-35 (510-5080)	None: Lead Wire Type		

★ Design Standards: None Japanese Standard "JIS", European Design Standard and N. American Design Standard

Graphic Symbols

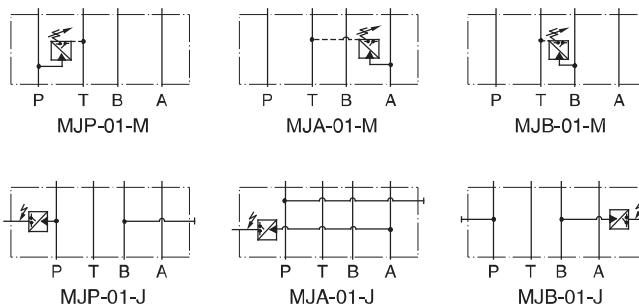

■ **Instructions**

- To make pressure adjustment, loosen the lock nut and turn the pressure adjustment screw clockwise or anti-clockwise. For an increase of pressure, turn the screw clockwise. Be sure to re-tighten the lock nut firmly after making adjustment to the pressure.
- Wiring of a sensitive switch should be made correctly referring to the table below. Numbers in the switch status column indicate wiring numbers in receptacles or contact numbers of connectors.

(Pressure with Sensitive Switch)
and The Switch Status

Operating Pressure	Switch Status
Less than Pressure setting	1 —○ 2 ○ 3
More than Pressure setting	1 —○ 2 ○ 3

■ **Attachment**

Valve Model No.	Attachment
MJ*-01-M-*10	Cable connector: NJC-203-PR 1 Pc.
MJ*-01-M-*N-10	DIN connector: GDM311-B-11... 1 Pc.

■ **Pressure Drop**

Hydraulic Fluid: Viscosity 35 mm²/s (164 SSU), Specific Gravity 0.850

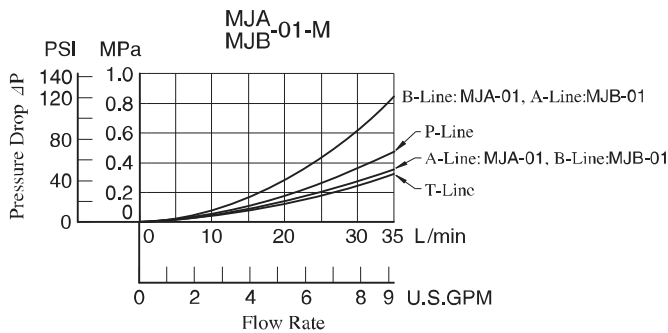
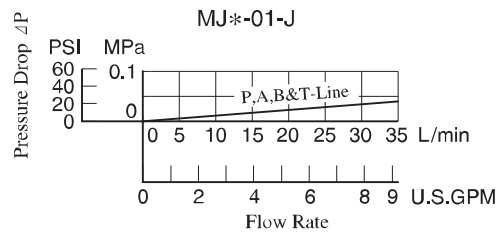
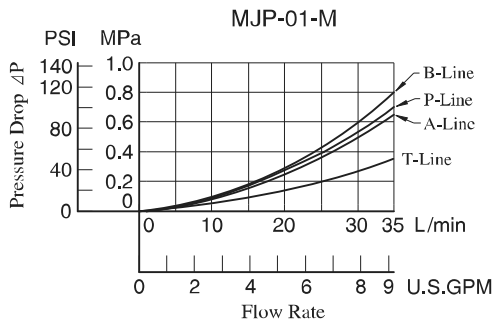

● Cable Connector Type
 MJP-01-M-*-10
 MJA-01-M-*-10

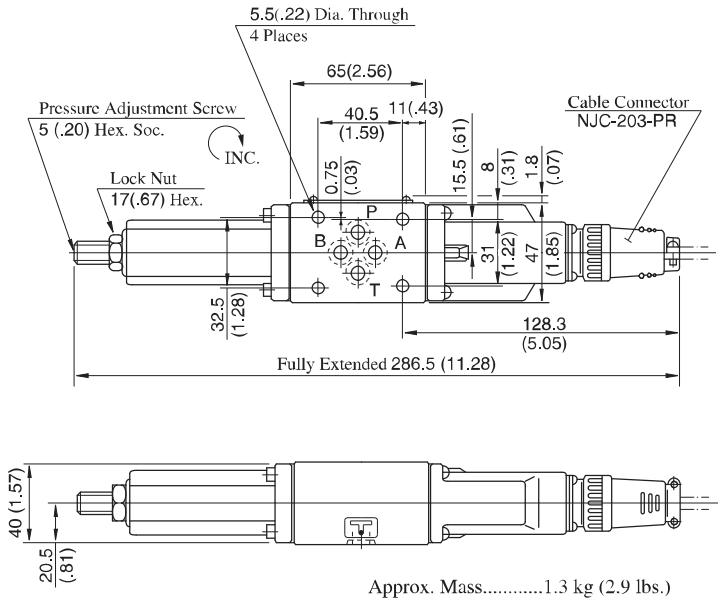

MJB-01-M-*-10

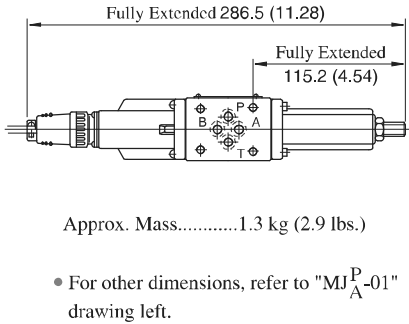

● Plug-in Connector Type
 MJP-01-M-*-N-10
 MJA-01-M-*-N-10

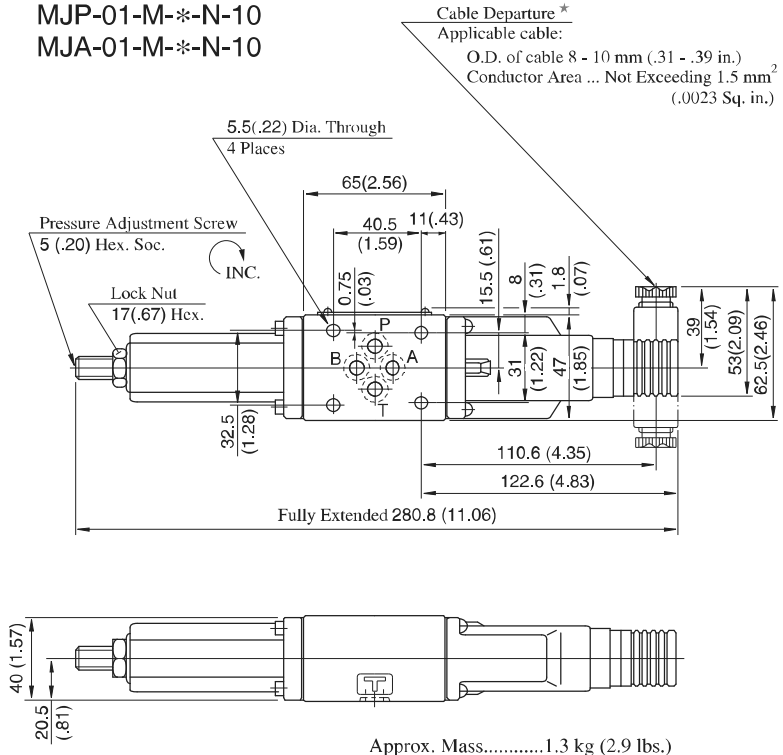

DIMENSIONS IN MILLIMETRES (INCHES)

MJB-01-M-*-N-10

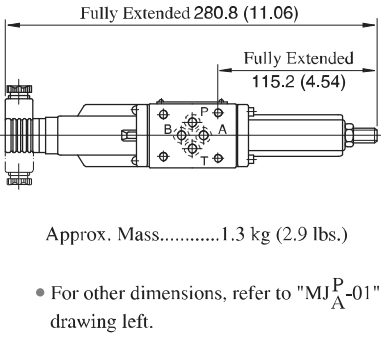

★ As shown by the dot-and-dash line, the cable departure can also be faced opposite.

F
 01 Series Modular Valves

● **Semiconductor Type Pressure Switch**

MJP-01-J-*-10

MJA-01-J-*-10

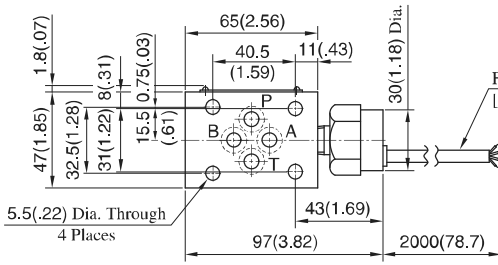

Four Conductor Cable
[5 mm(.20 in.) O.D.]
RED---Power Supply ⊕
BLACK---Power Supply ⊖
WHITE---Output ⊕
GREEN---Output ⊖

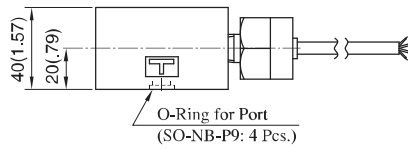
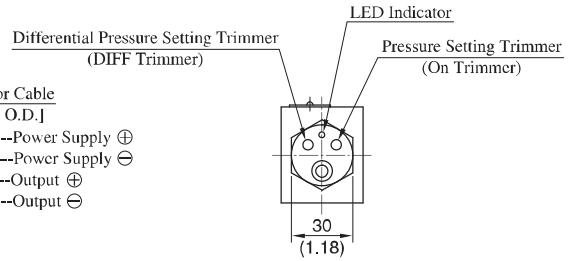

Approx. Mass.....1 kg (2.2 lbs.)

MJB-01-J-*-10

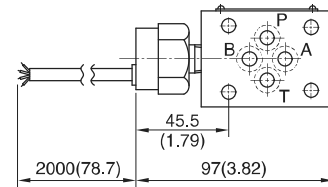

Approx. Mass.....1 kg (2.2 lbs.)

● For other dimensions, refer to "MJ^P_A-01" drawing left.

■ **Spare Parts List**

● **Plug-in Connector Type**

MJP
MJA-01-M-*-N-10
MJB

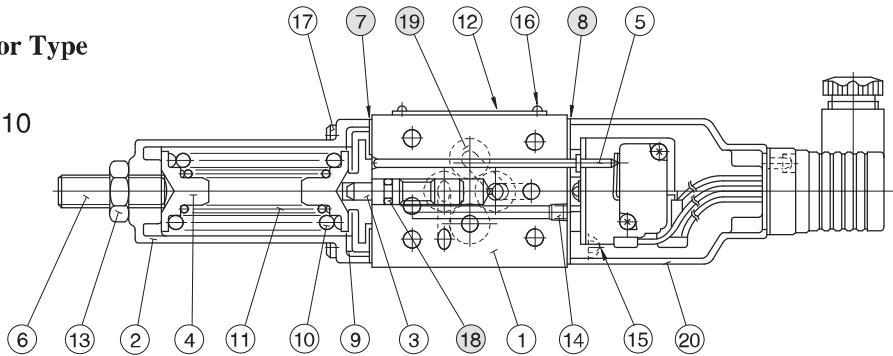

● **Cable Connector Type**

MJP
MJA-01-M-*-10
MJB

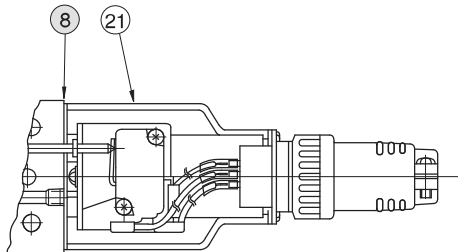

● **List of Seals**

Item	Name of Parts	Part Numbers	Qty.
7	Packing	3116-VK414239-4	1
8	Packing	3116-VK414240-2	1
18	O-Ring	SO-NA-P5	1
19	O-Ring	SO-NB-P9	4

Note: When ordering seals, please specify the seal kit number from the table below.

● **List of Seal Kits**

Valve Model No.	Seal Kit Numbers
MJP-01	Included in seal kit Kit No.: KS-MJP-01-10
MJA-01	
MJB-01	

● Since MJ*-01-J-*-10 (Semiconductor type pressure switch) does not have any seals inside, only four(4) O-rings for the ports are required. Please refer to the above drawing.

Pressure and Temperature Compensated Flow Control (and Check) Modular Valves

Specifications

Model Numbers	Max. Operating Pressure MPa (PSI)	Max. Metred Flow L/min (U.S.GPM)	Max. Free Flow L/min (U.S.GPM)
MFP-01-10	16 (2320)	35 (9.25)	—
MFA-01-*-10			35 (9.25)
MFB-01-*-10 MFW-01-*-10			

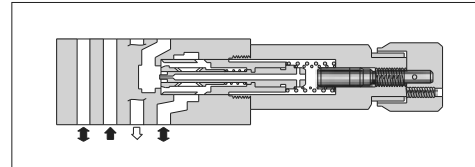

Model Number Designation

F-	MFA	-01	-X	-10	
Special Seals	Series Number	Valve Size	Direction of Flow	Design Number	Design Standard
F: Special Seals for Phosphate Ester Type Fluids (Omit if not required)	MFP : Flow Control Valve for P-Line	01	—	10	Refer to ★
	MFA : Flow Control and Check Valve for A-Line MFB : Flow Control and Check Valve for B-Line MFW : Flow Control and Check Valve for A&B-Lines		X : Metre-out Y : Metre-in	10	

★ Design Standards: None Japanese Standard "JIS", European Design Standard and N. American Design Standard

Instructions

- To make flow rate adjustment, loosen locking screw for the dial and turn the flow adjustment dial clockwise or anti-clockwise. For a decrease of flow, turn the dial clockwise. Be sure to re-tighten the locking screw firmly after the adjustment of the flow rate.

Graphic Symbols

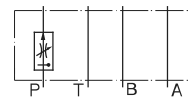

MFP-01

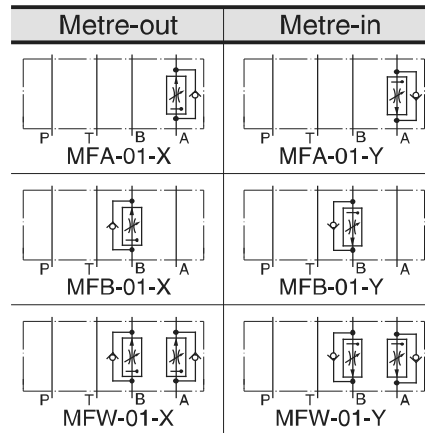

F

01 Series Modular Valves

■ Typical Performance Characteristics

Hydraulic Fluid: Viscosity 35 mm²/s (164 SSU), Specific Gravity 0.850

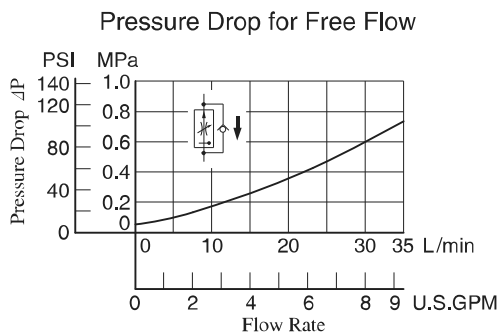
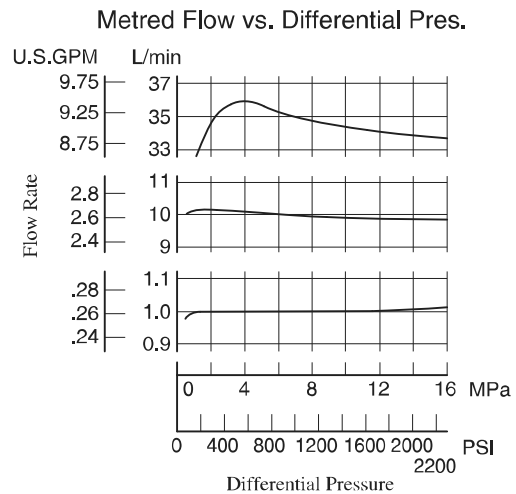
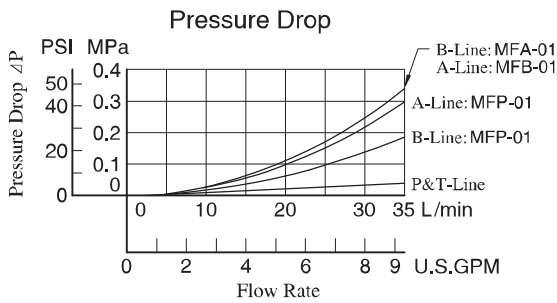
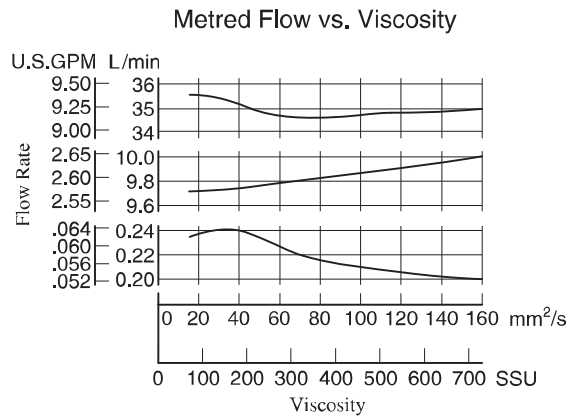
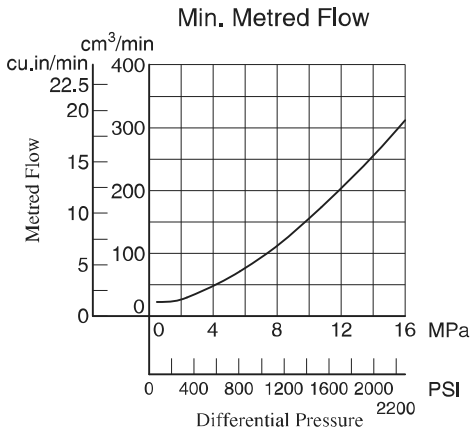
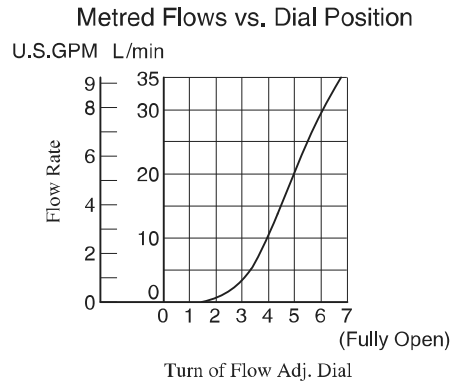
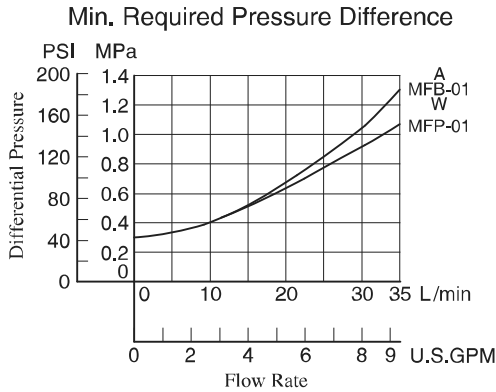

MFP-01-10

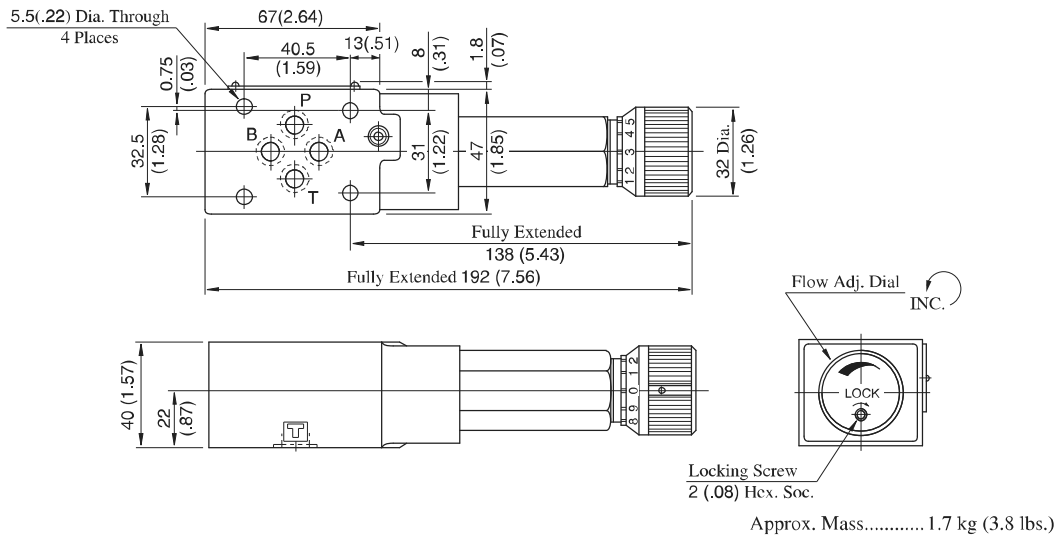

MFW-01-X-10

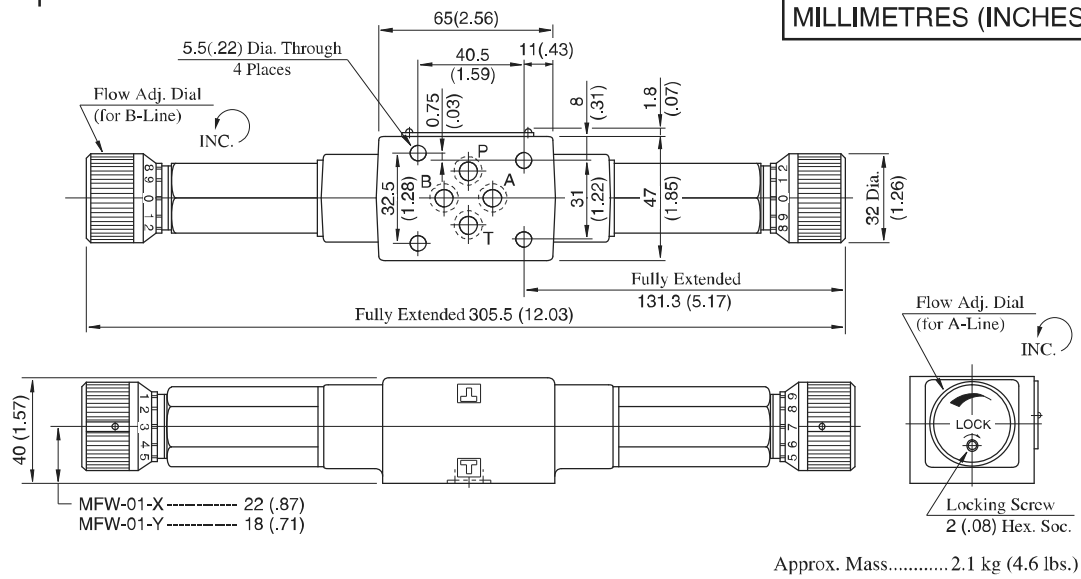

DIMENSIONS IN
MILLIMETRES (INCHES)

MFA-01-X-10

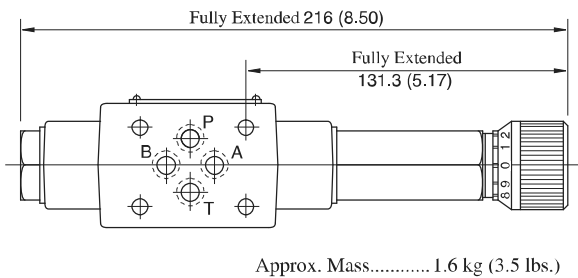

MFB-01-X-10

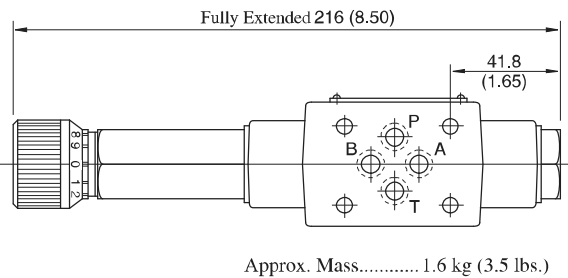

• For other dimensions, refer to "MFW-01" drawing above.

F

01 Series Modular Valves

■ Spare Parts List

MFP-01-10

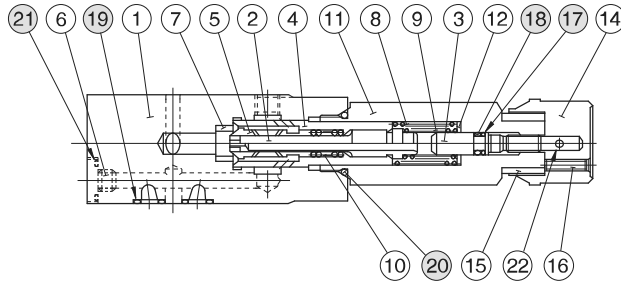

MFW-01-X_Y-10

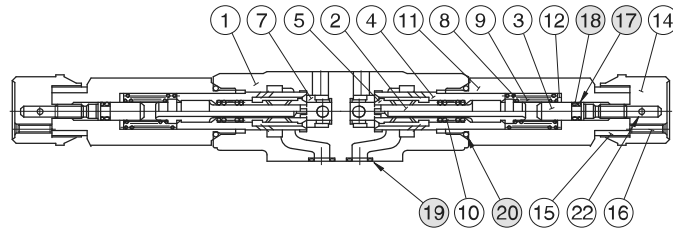

MFA-01-X_Y-10

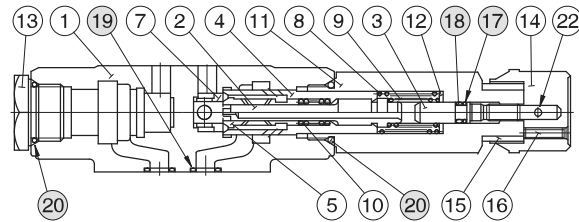

MFB-01-X_Y-10

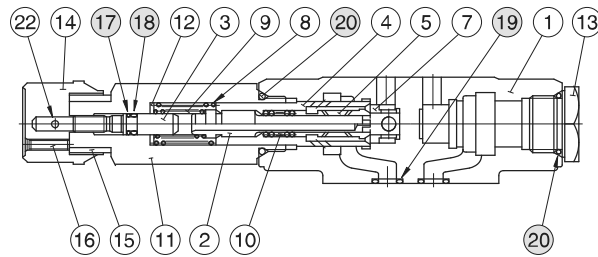

● List of Seals

Item	Name of Parts	Part Numbers	Quantity			
			MFP-01	MFA-01	MFB-01	MFW-01
17	Back Up Ring	SO-BB-P6	1	1	1	2
18	O-Ring	SO-NA-P6	1	1	1	2
19	O-Ring	SO-NB-P9	4	4	4	4
20	O-Ring	SO-NB-P18	1	2	2	2
21	O-Ring	SO-NB-P10	1	—	—	—

● List of Seal Kits

Valve Model Numbers	Seal Kit Numbers
MFP-01	KS-MFP-01-10
MFA-01	KS-MFA-01-10
MFB-01	
MFW-01	KS-MFW-01-10

Note: When ordering seals, please specify the seal kit number from the table right.

Temperature Compensated Throttle and Check Modular Valves

Specifications

Model Numbers	Max. Operating Pressure MPa (PSI)	Max. Differential Pressure MPa (PSI)	Max. Metred Flow L/min (U.S.GPM)	Min. Metred Flow L/min (U.S.GPM)	Max. Free Flow L/min (U.S.GPM)
MSTA-01-X-10 MSTB-01-X-10 MSTW-01-X-10	31.5 (4570)	14 (2030)	35 (9.25)	0.5 (.13)	35 (9.25)

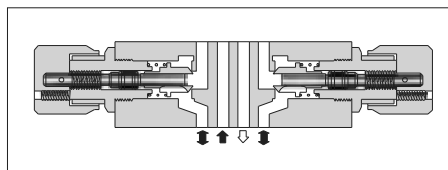

Model Number Designation

F-	MSTA	-01	-X	-10	*
Special Seals	Series Number	Valve Size	Direction of Flow	Design Number	Design Standard
F: Special Seals for Phosphate Ester Type Fluids (Omit if not required)	MSTA: Temperature Compensated Throttle and Check Valve for A-Line MSTB: Temperature Compensated Throttle and Check Valve for B-Line MSTW: Temperature Compensated Throttle and Check Valve for A&B-Lines	01	X: Metre-out	10	Refer to ★

★ Design Standards: None Japanese Standard "JIS", European Design Standard and N. American Design Standard

Instructions

- To make flow rate adjustment, loosen locking screw for the dial and turn the flow adjustment dial clockwise or anti-clockwise. For a decrease of flow, turn the dial clockwise. Be sure to re-tighten the locking screw firmly after the adjustment of the flow rate.

Graphic Symbols

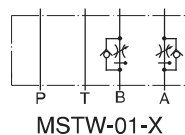
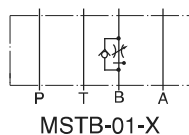
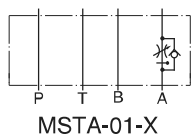

F
01 Series Modular Valves

■ Typical Performance Characteristics

Hydraulic Fluid: Viscosity 35 mm²/s (164 SSU), Specific Gravity 0.850

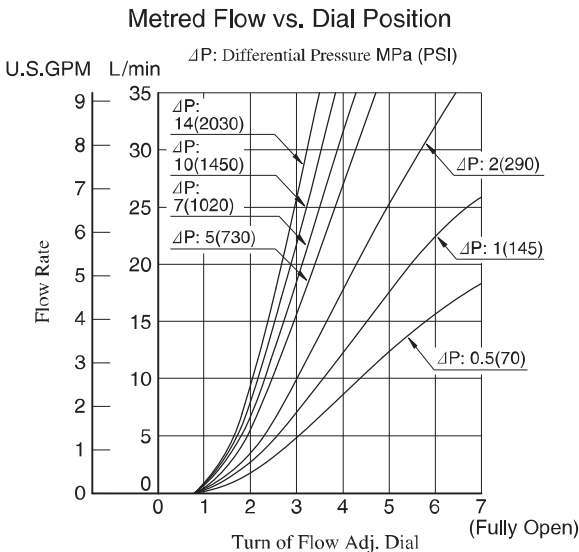
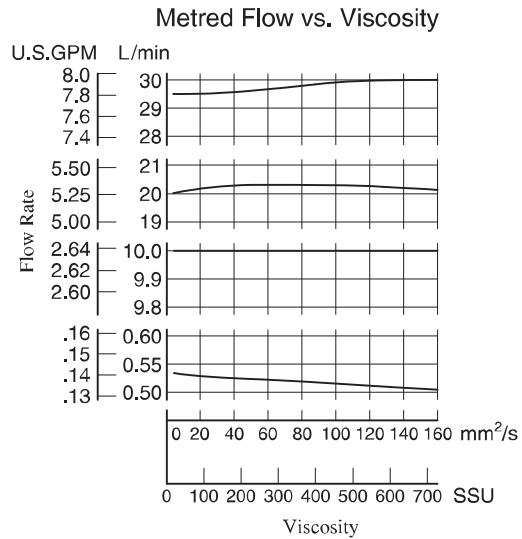
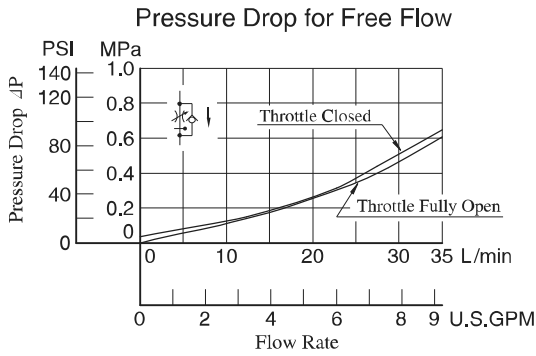
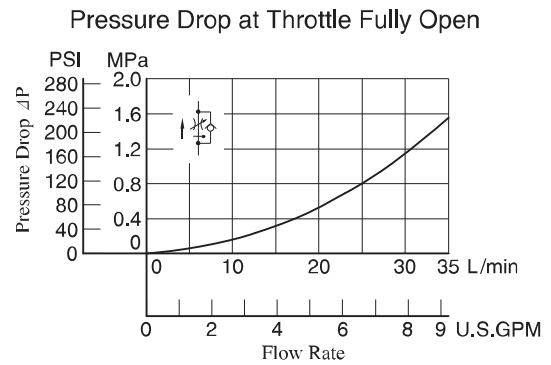
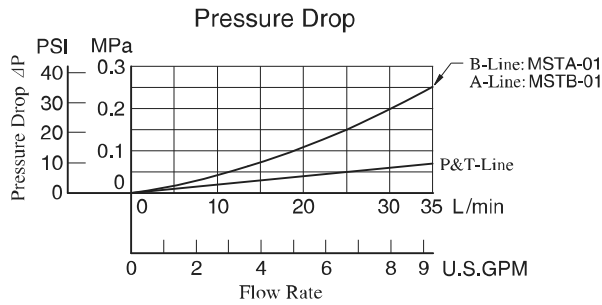

MSTW-01-X-10

DIMENSIONS IN MILLIMETRES (INCHES)

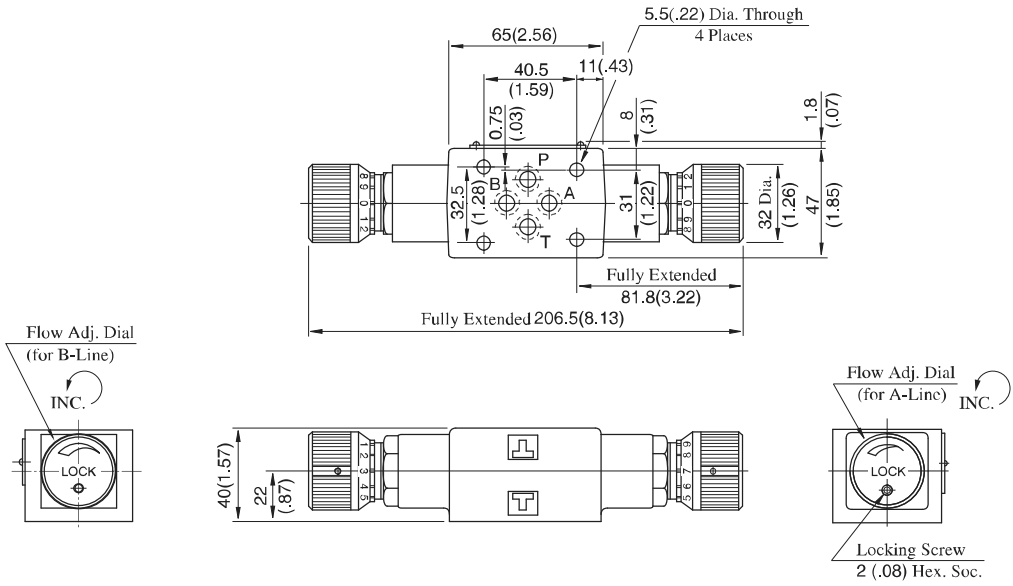

Approx. Mass..... 1.5 kg (3.3 lbs.)

MSTA-01-X-10

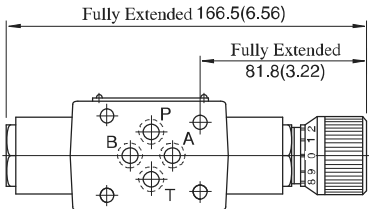

Approx. Mass..... 1.3 kg (2.9 lbs.)

MSTB-01-X-10

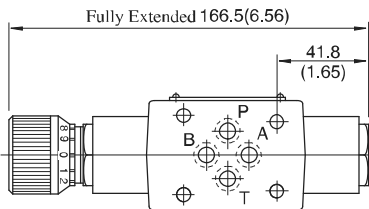

Approx. Mass..... 1.3 kg (2.9 lbs.)

• For other dimensions, refer to "MSTW-01" drawing above.



■ Spare Parts List

MSTA-01-X-10

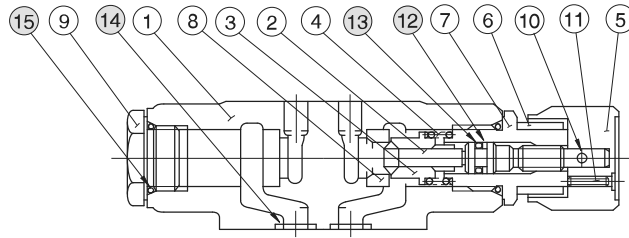

MSTB-01-X-10

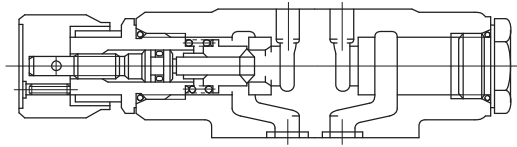

MSTW-01-X-10

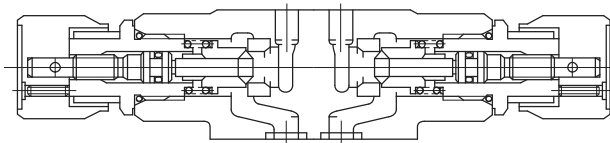

● List of Seals

Item	Name of Parts	Part Numbers	Quantity		
			MSTA	MSTB	MSTW
12	Back Up Ring	SO-BB-P6	1	1	2
13	O-Ring	SO-NA-P6	1	1	2
14	O-Ring	SO-NB-P9	4	4	4
15	O-Ring	SO-NB-P18	2	2	2

Note: When ordering seals, please specify the seal kit number from the table right.

● List of Seal Kits

Valve Model Numbers	Seal Kit Numbers
MSTA-01	KS-MFA-01-10
MSTB-01	
MSTW-01	KS-MFW-01-10

Throttle Modular Valves

Specifications

Model Number	Max. Operating Pressure MPa (PSI)	Max. Flow L/min (U.S.GPM)
MSP-01-50	31.5 (4570)	60 (15.9)*

★ At the low differential pressure, maximum flow is limited. See "Pressure Drop at Throttle Fully Open".

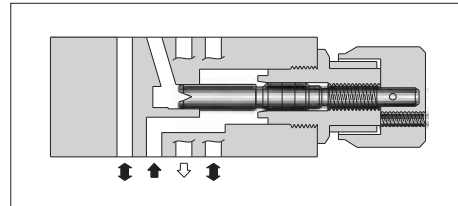

Model Number Designation

F-	MSP	-01	-50	*
Special Seals	Series Number	Valve Size	Design Number	Design Standard
F: Special Seals for Phosphate Ester Type Fluids (Omit if not required)	MSP : Throttle Valve for P-Line	01	50	Refer to ★

★ Design Standards: None..... Japanese Standard "JIS", European Design Standard and N. American Design Standard

Graphic Symbol

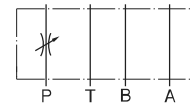

Typical Performance Characteristics

Hydraulic Fluid: Viscosity 35 mm²/s (164 SSU), Specific Gravity 0.850

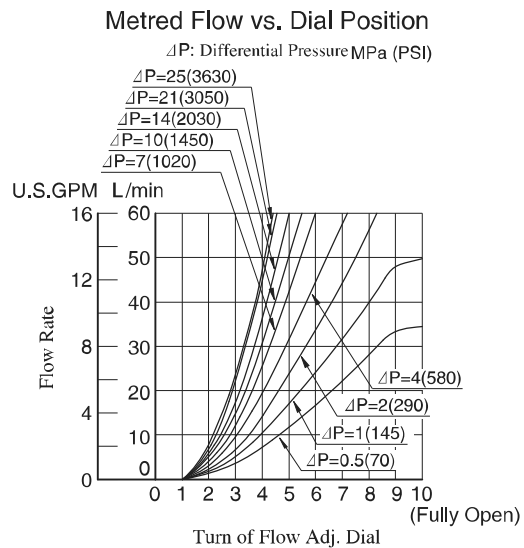
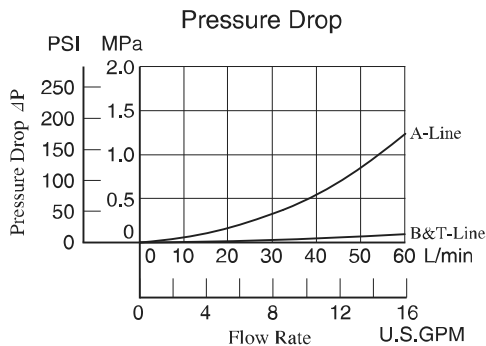
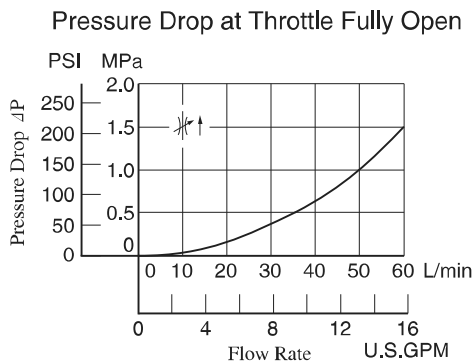

Instructions

- To make flow rate adjustment, loosen locking screw for the dial and turn the flow adjustment dial clockwise or anti-clockwise. For a decrease of flow, turn the dial clockwise. Be sure to re-tighten the locking screw firmly after the adjustment of the flow rate.

01 Series Modular Valves

MSP-01-50

**DIMENSIONS IN
MILLIMETRES (INCHES)**

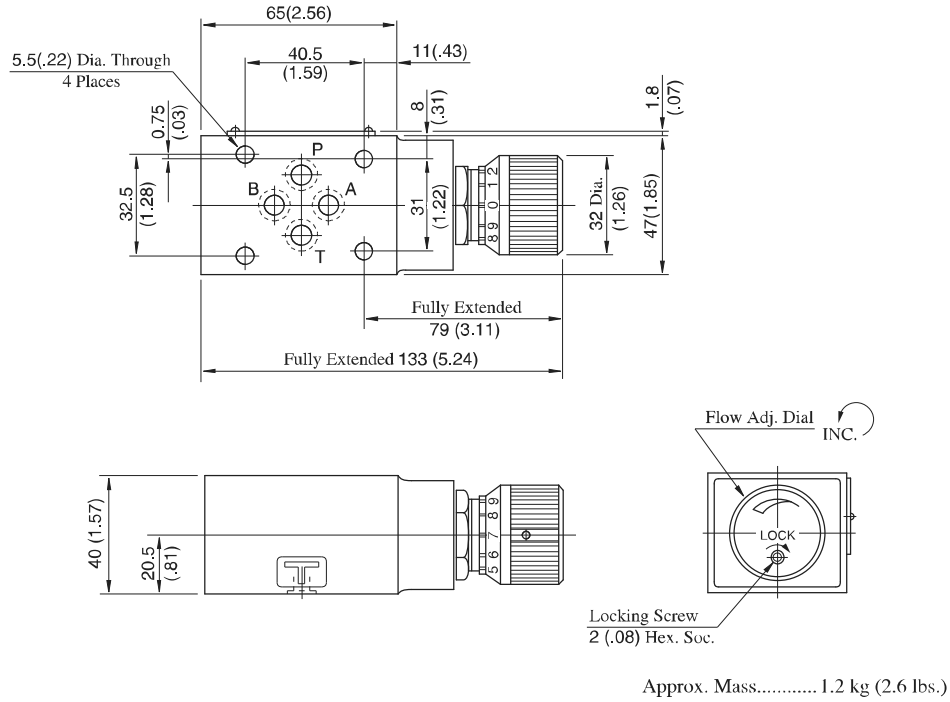

■ Spare Parts List

MSP-01-50

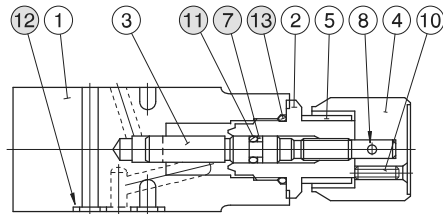

● List of Seals

Item	Name of Parts	Part Numbers	Qty.	Remarks
7	Back Up Ring	SO-BB-P6	1	Included in Seal Kit Kit No.: KS-MSP-01-50
11	O-Ring	SO-NA-P6	1	
12	O-Ring	SO-NB-P9	4	
13	O-Ring	SO-NB-P18	1	

Check and Throttle Modular Valves

Specifications

Model Number	Max. Operating Pressure MPa (PSI)	Max. Flow L/min (U.S.GPM)
MSCP-01-30	31.5 (4570)	35 (9.25)*

★ At the low differential pressure, maximum flow is limited. See "Pressure Drop at Throttle Fully Open".

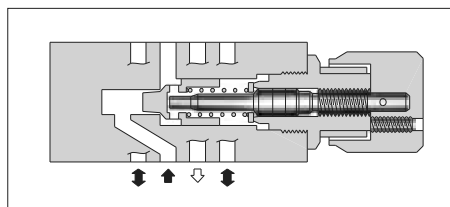

Model Number Designation

F-	MSCP	-01	-30	*
Special Seals	Series Number	Valve Size	Design Number	Design Standard
F: Special Seals for Phosphate Ester Type Fluids (Omit if not required)	MSCP : Check and Throttle Valve for P-Line	01	30	Refer to ★

★ Design Standards: None Japanese Standard "JIS", European Design Standard and N. American Design Standard

Graphic Symbol

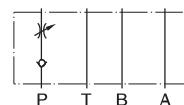

Typical Performance Characteristics

Hydraulic Fluid: Viscosity 35 mm²/s (164 SSU), Specific Gravity 0.850

Pressure Drop at Throttle Fully Open

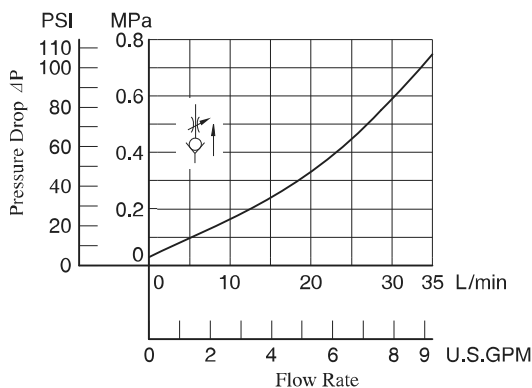

Metred Flow vs. Dial Position

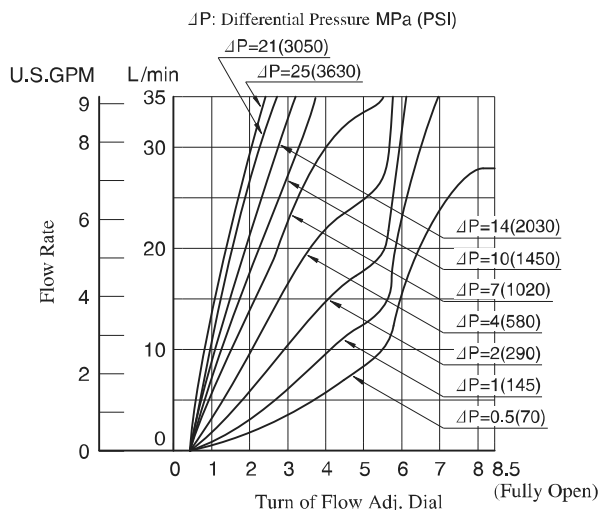

Pressure Drop

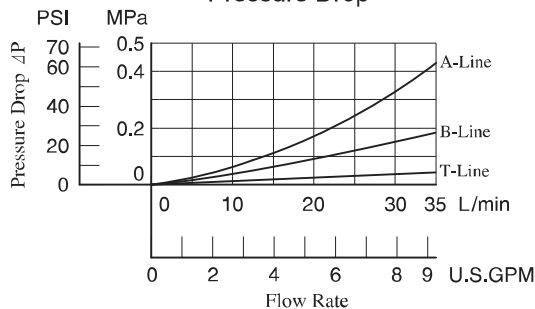

Instructions

- To make flow rate adjustment, loosen locking screw for the dial and turn the flow adjustment dial clockwise or anti-clockwise. For a decrease of flow, turn the dial clockwise. Be sure to re-tighten the locking screw firmly after the adjustment of the flow rate.

01 Series Modular Valves

MSCP-01-30

**DIMENSIONS IN
MILLIMETRES (INCHES)**

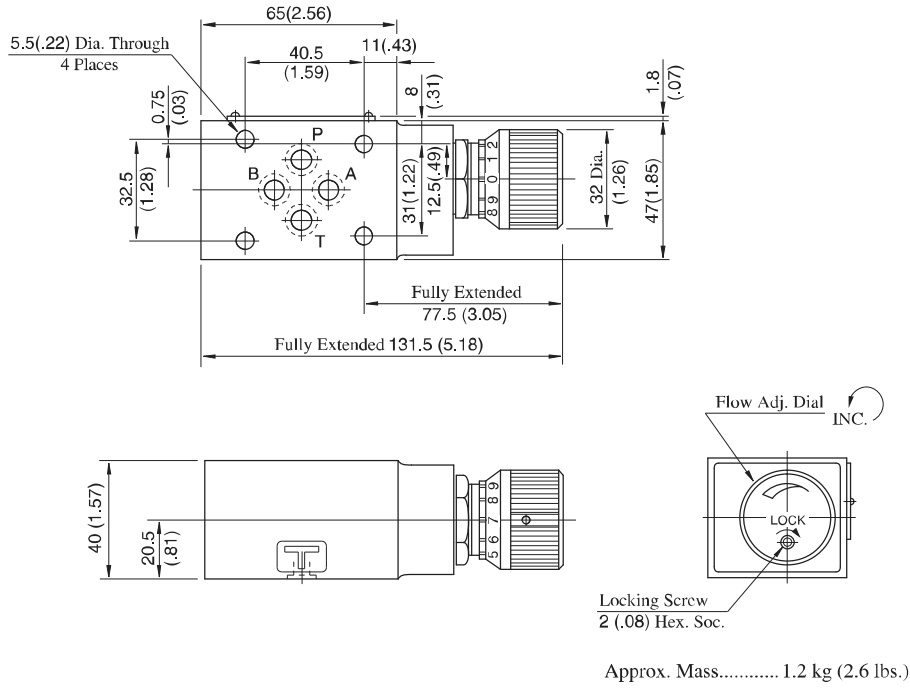

■ Spare Parts List

MSCP-01-30

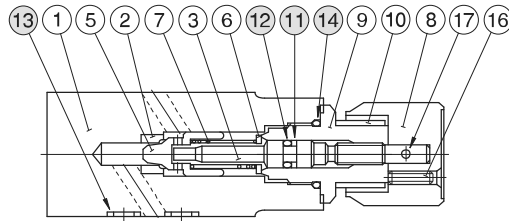

● List of Seals

Item	Name of Parts	Part Numbers	Qty.	Remarks
11	Back Up Ring	SO-BB-P6	1	Included in Seal Kit Kit No.: KS-MSP-01-30
12	O-Ring	SO-NA-P6	1	
13	O-Ring	SO-NB-P9	4	
14	O-Ring	SO-NB-P18	1	

Throttle and Check Modular Valves

Specifications

Model Numbers	Max. Operating Pressure MPa (PSI)	Max. Flow L/min (U.S.GPM)
MSA-01-**-50 MSB-01-**-50 MSW-01-**-50	31.5 (4570)	60 (15.9)*

★ At the low differential pressure, maximum flow is limited. See "Pressure Drop at Throttle Fully Open" of the next page.

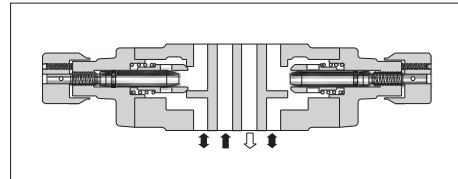

Model Number Designation

F-	MSW	-01	-X	Y	-50	*
Special Seals	Series Number	Valve Size	Direction of Flow ("A" Line)	Direction of Flow ("B" Line)	Design Number	Design Standard
F: Special Seals for Phosphate Ester Type Fluids (Omit if not required)	MSA : Throttle and Check Valve for A-Line	01	X : Metre-out Y : Metre-in	—	50	Refer to ★
	MSB : Throttle and Check Valve for B-Line		—	X : Metre-out Y : Metre-in		
	MSW : Throttle and Check Valve for A&B-Lines		X : Metre-out Y : Metre-in			
			X : Metre-out Y : Metre-in	Y : Metre-in X : Metre-out		

★ Design Standards: None Japanese Standard "JIS", European Design Standard and N. American Design Standard

Instructions

- To make flow rate adjustment, loosen locking screw for the dial and turn the flow adjustment dial clockwise or anti-clockwise. For a decrease of flow, turn the dial clockwise. Be sure to re-tighten the locking screw firmly after the adjustment of the flow rate.

Graphic Symbols

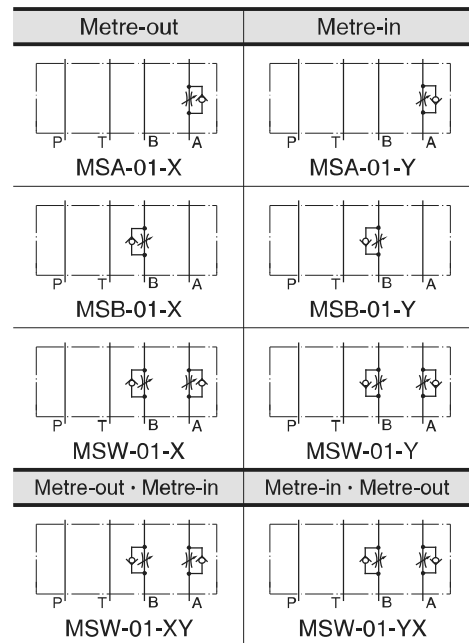

F

01 Series Modular Valves

■ Typical Performance Characteristics

Hydraulic Fluid: Viscosity 35 mm²/s (164 SSU), Specific Gravity 0.850

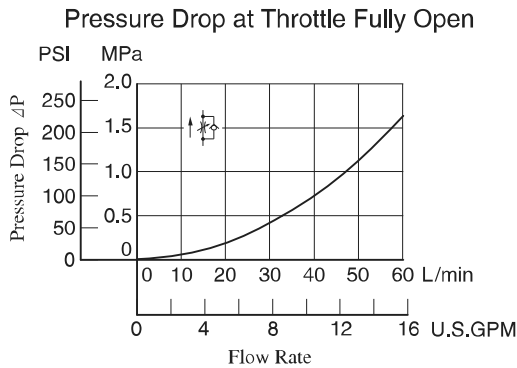
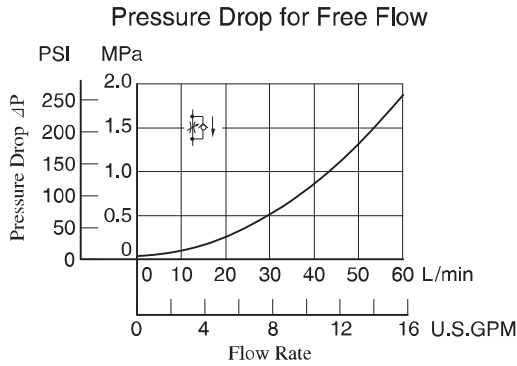
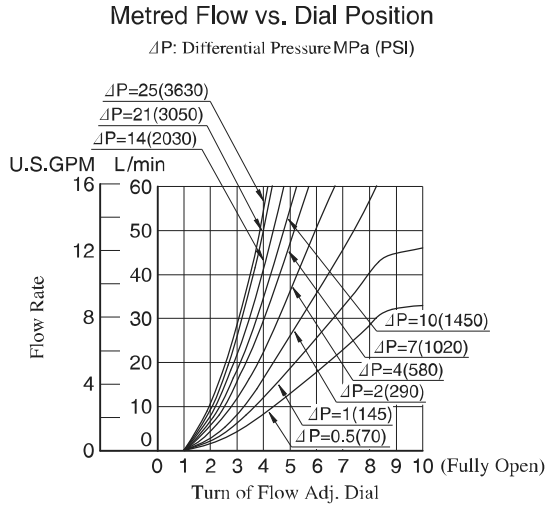
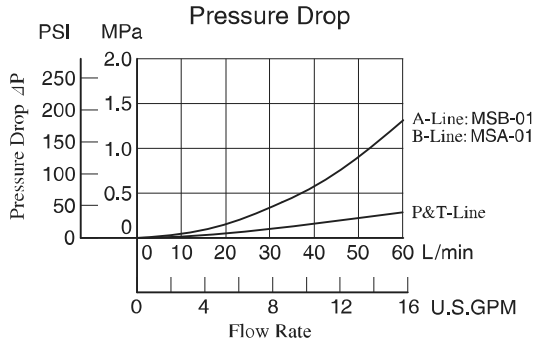

■ Application

● Circuit of Clamp Cylinder for Injection Molding Machine

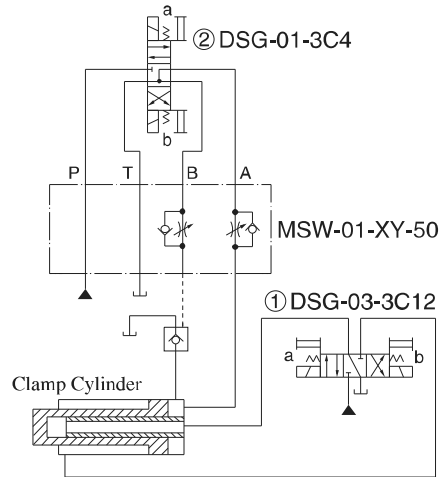

● Operation Sequence

Clamp Cylinder	Advance	End Point Pressurisation	Decompression	Retreat
Solenoid Operated Directional Valve ①	Sol.a ON	→	Centre Position	Sol.b ON
Solenoid Operated Directional Valve ②	Sol.b ON	Sol.a ON	Sol.b ON	→

MSW-01-X_Y-50

DIMENSIONS IN MILLIMETRES (INCHES)

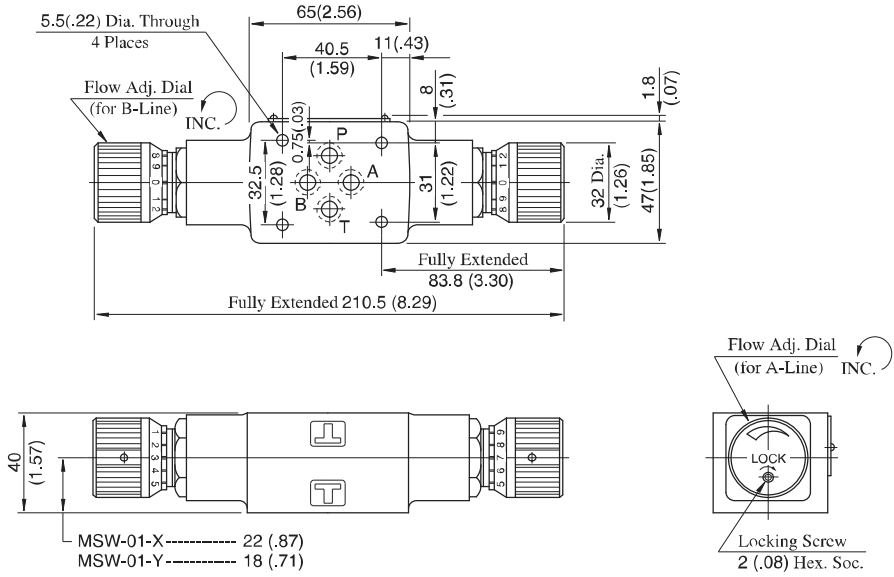

Approx. Mass..... 1.5 kg (3.3 lbs.)

MSW-01-XY_{YX}-50

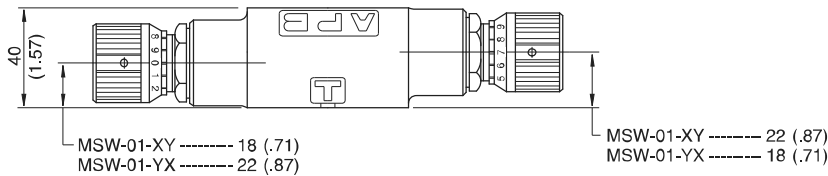

Approx. Mass..... 1.5 kg (3.3 lbs.)

• For other dimensions, refer to "MSW-01-X_Y" drawing above.

MSA-01-X_Y-50

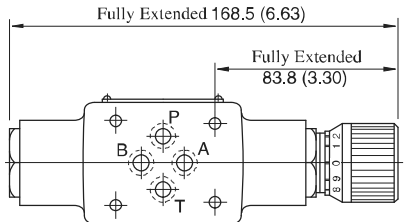

Approx. Mass..... 1.3 kg (2.9 lbs.)

MSB-01-X_Y-50

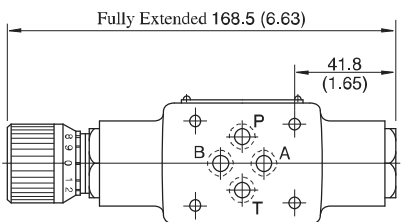

Approx. Mass..... 1.3 kg (2.9 lbs.)

• For other dimensions, refer to "MSW-01" drawing above.

01 Series Modular Valves

■ Spare Parts List

MSA-01-X-Y-50

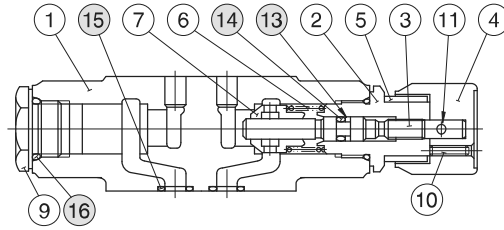

MSB-01-X-Y-50

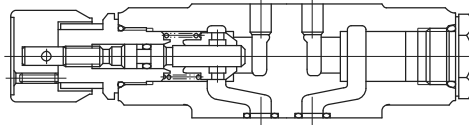

MSW-01-**-50

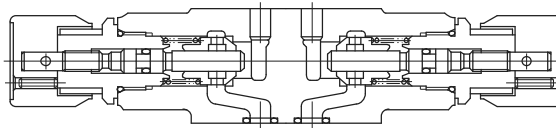

● List of Seals

Item	Name of Parts	Part Numbers	Quantity	
			MSA,MSB	MSW
13	Back Up Ring	SO-BB-P6	1	2
14	O-Ring	SO-NA-P6	1	2
15	O-Ring	SO-NB-P9	4	4
16	O-Ring	SO-NB-P18	2	2

Note: When ordering seals, please specify the seal kit number from the table right.

● List of Seal Kits

Valve Model Numbers	Seal Kit Numbers
MSA-01	KS-MSA-01-30
MSB-01	
MSW-01	KS-MSW-01-30

Check Modular Valves

Specifications

Model Numbers	Max. Operating Pressure MPa (PSI)	Max. Flow L/min (U.S.GPM)
MCP-01-*-30 MCT-01-*-30	31.5 (4570)	35 (9.25)

Model Number Designation

F-	MCP	-01	-0	-30	*
Special Seals	Series Number	Valve Size	Cracking Pressure MPa (PSI)	Design Number	Design Standard
F: Special Seals for Phosphate Ester Type Fluids (Omit if not required)	MCP: Check Valve for P-Line MCT: Check Valve for T-Line	01	0: 0.035 (5) 2: 0.2 (29) 4: 0.4 (58)	30	Refer to ★

★ Design Standards: None Japanese Standard "JIS", European Design Standard and N. American Design Standard

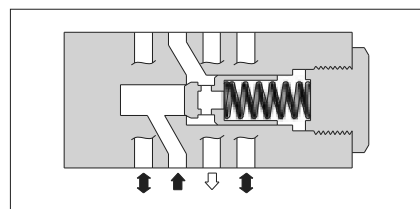

Graphic Symbols

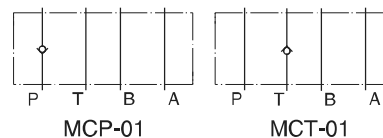

Typical Performance Characteristics

Hydraulic Fluid: Viscosity 35 mm²/s (164 SSU),
Specific Gravity 0.850

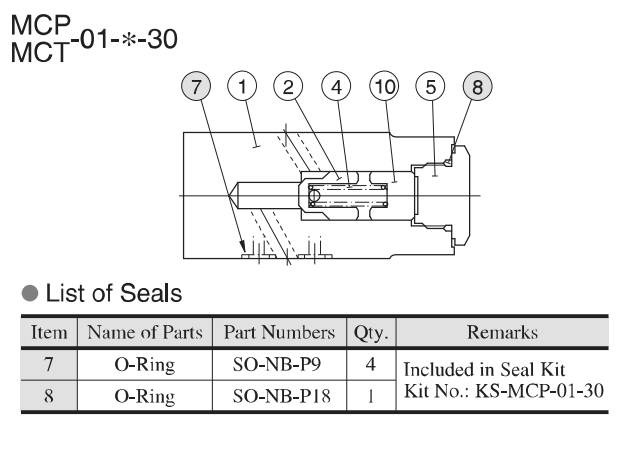
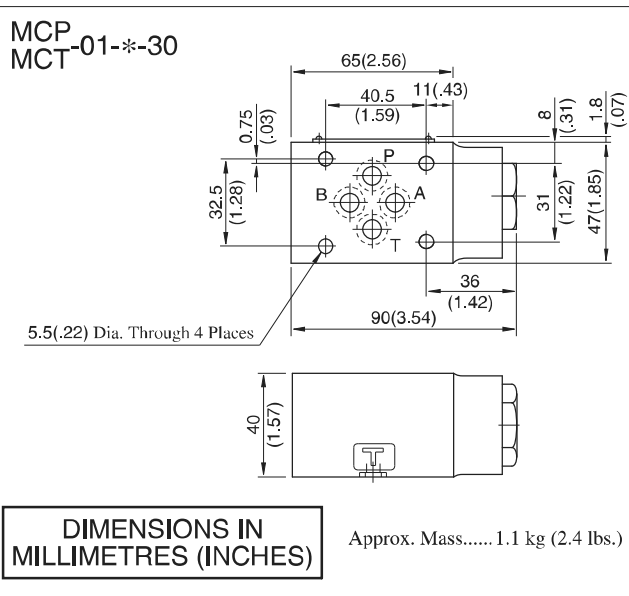
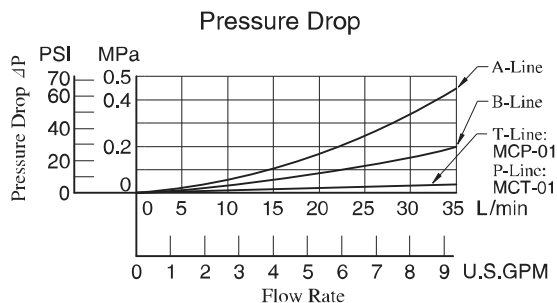
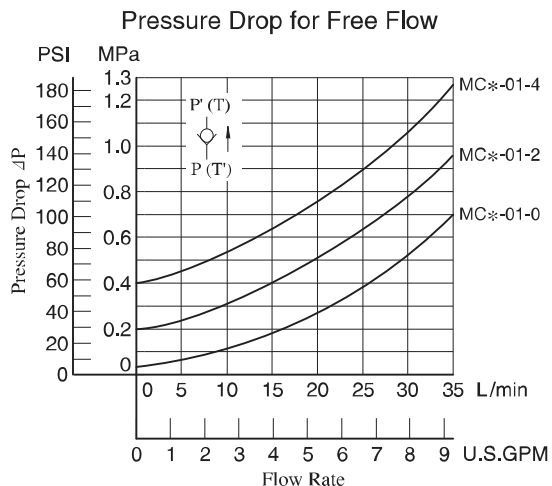

01 Series Modular Valves

Anti-Cavitation Modular Valves

Specifications

Model Number	Max. Operating Pressure MPa (PSI)	Max. Flow L/min (U.S.GPM)
MAC-01-30	31.5 (4570)	35 (9.25)

Model Number Designation

F-	MAC	-01	-30	*
Special Seals	Series Number	Valve Size	Design Number	Design Standard
F: Special Seals for Phosphate Ester Type Fluids (Omit if not required)	MAC: Anti-Cavitation Valve	01	30	Refer to ★

★ Design Standards: None Japanese Standard "JIS", European Design Standard and N. American Design Standard

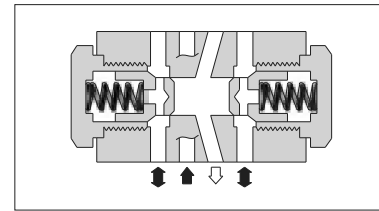

Graphic Symbol

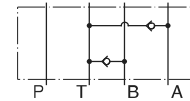

Pressure Drop

Hydraulic Fluid: Viscosity 35 mm²/s (164 SSU),
Specific Gravity 0.850

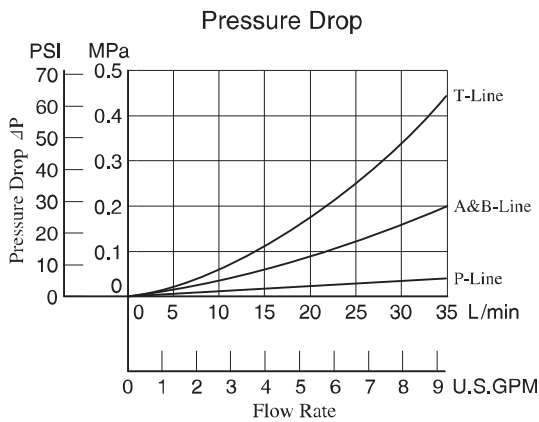

MAC-01-30

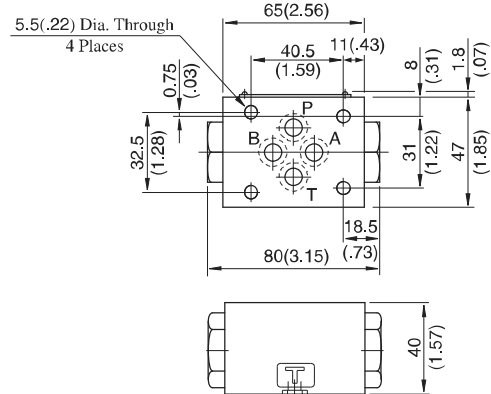

DIMENSIONS IN MILLIMETRES (INCHES)

Approx. Mass.....0.8 kg (1.8 lbs.)

MAC-01-30

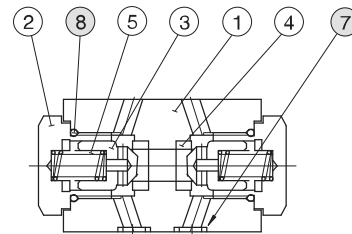

● List of Seals

Item	Name of Parts	Part Numbers	Qty.	Remarks
7	O-Ring	SO-NB-P9	4	Included in Seal Kit Kit No.: KS-MAC-01-30
8	O-Ring	SO-NB-P18	2	

Pilot Operated Check Modular Valves

Specifications

Model Numbers		Max. Operating Pressure MPa (PSI)	Max. Flow L/min (U.S.GPM)
Standard	MP*-01-*-40	31.5 (4570)	35 (9.25)
Low Pilot Pressure Control Type	MP*-01-*-4001		

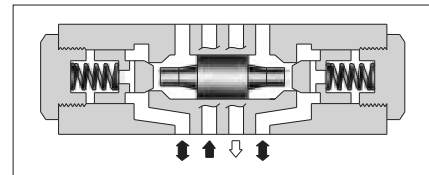
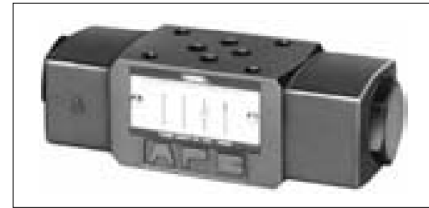

Model Number Designation

F-	MPA	-01	-2	-40	*
Special Seals	Series Number	Valve Size	Cracking Pressure MPa (PSI)	Design Number	Design Standard
F: Special Seals for Phosphate Ester Type Fluids (Omit if not required)	MPA : Pilot Operated Check Valve for A-Line MPB : Pilot Operated Check Valve for B-Line MPW : Pilot Operated Check Valve for A&B-Lines	01	2 : 0.2 (29) 4 : 0.4 (58)	40 (Standard) 4001 (Low Pilot Pressure Control Type)	Refer to ★

★ Design Standards: None Japanese Standard "JIS", European Design Standard and N. American Design Standard

Graphic Symbols

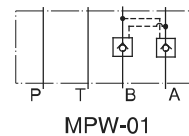
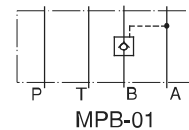
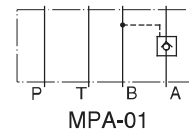

Typical Performance Characteristics

Hydraulic Fluid: Viscosity 35 mm²/s (164 SSU),
Specific Gravity 0.850

Pressure Drop for Free Flow

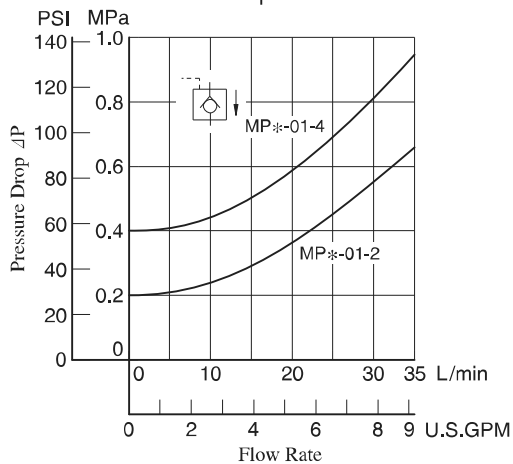

Pressure Drop for Reversed Controlled Flow

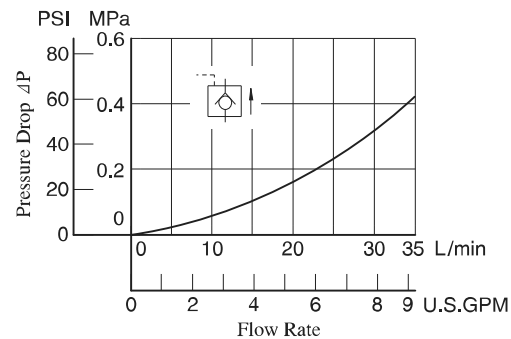

Pressure Drop

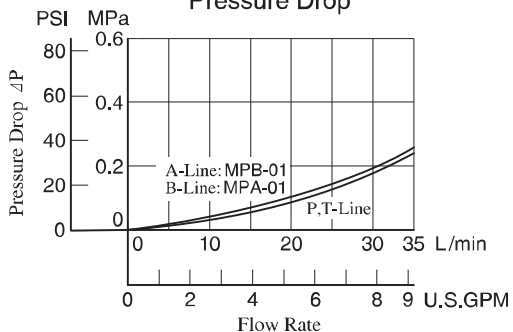

Min. Pilot Pressure

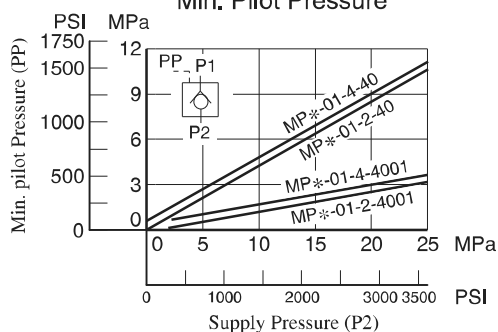

F
01 Series Modular Valves

MPA-01-*-40/4001
 MPB-01-*-40/4001
 MPW-01-*-40/4001

**DIMENSIONS IN
 MILLIMETRES (INCHES)**

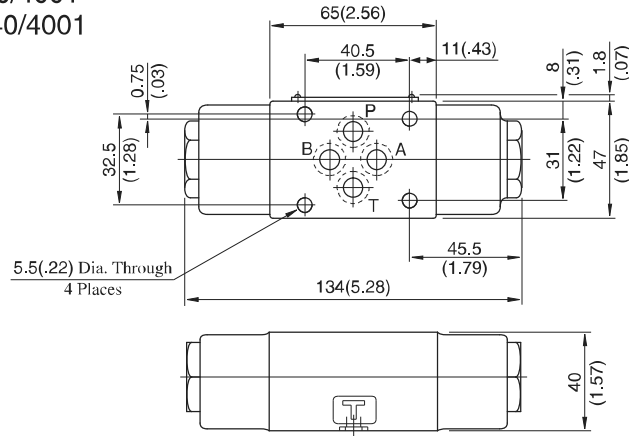

Approx. Mass..... 1.2 kg (2.6 lbs.)

■ Spare Parts List

MPW-01-*-40

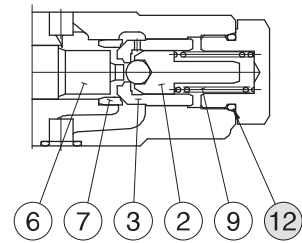
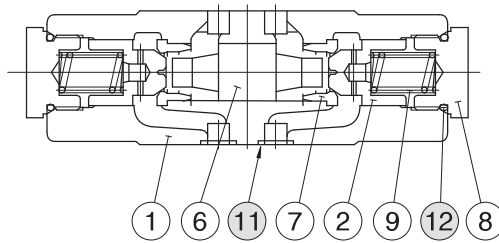

Low Pilot Pressure Control Type
 (MPW-01-*-4001)

MPA-01-*-40

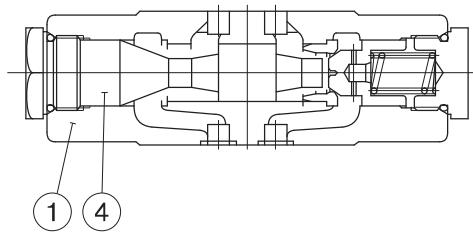

MPB-01-*-40

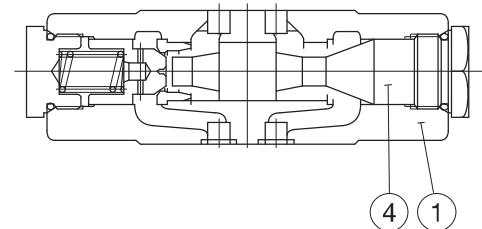

● List of Seals

Item	Name of Parts	Part Numbers	Qty.	Remarks
11	O-Ring	SO-NB-P9	4	Included in Seal Kit
12	O-Ring	SO-NB-P18	2	Kit No.: KS-MAC-01-30

End Plates

Blocking plates are used for auxiliary mounting surface or for closing unnecessary circuits.

Bypass plates are used for unidirectional circuits that require no solenoid operated directional valves.

Specifications

Model Numbers	Max. Operating Pressure MPa (PSI)	Max. Flow L/min (U.S.GPM)
MDC-01-*30	31.5 (4570)	35 (9.25)



Graphic Symbols

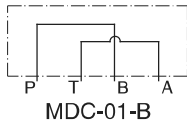

Model Number Designation

F-	MDC	-01	-A	-30	*
Special Seals	Series Number	Plate Size	Type of Plate	Design Number	Design Standard
F: Special Seals for Phosphate Ester Type Fluids (Omit if not required)	MDC: End Plate	01	A: Blocking Plate B: Bypass Plate	30	Refer to ★

★ Design Standards: None Japanese Standard "JIS", European Design Standard and N. American Design Standard

Typical Performance Characteristics

Hydraulic Fluid: Viscosity 35 mm²/s (164 SSU),
Specific Gravity 0.850

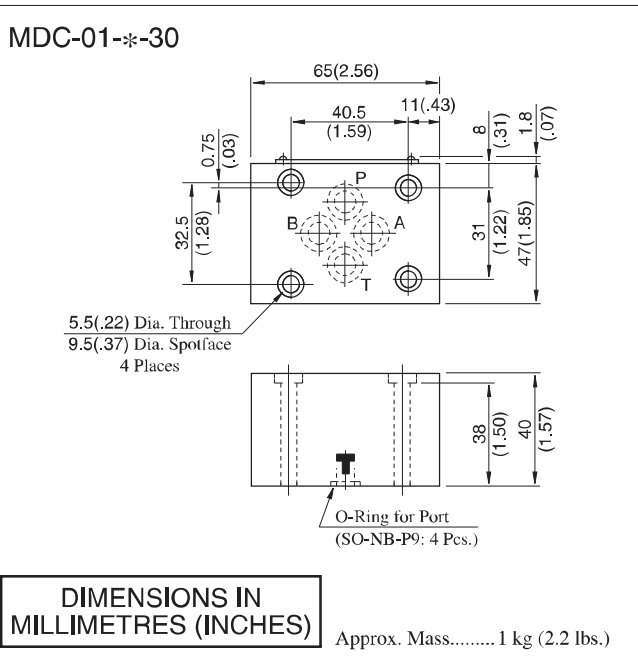
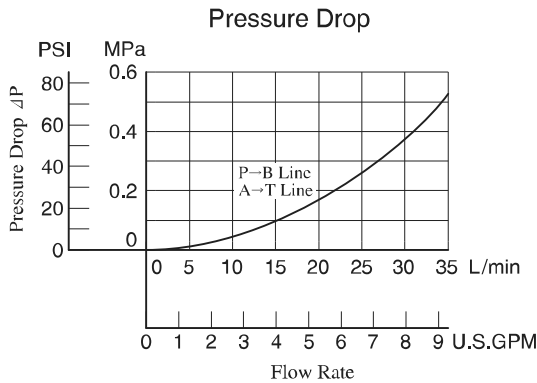

01 Series Modular Valves

Connecting Plate

These plates are used for detecting pressure of each line.

Specifications

Model Numbers	Max. Operating Pressure MPa (PSI)	Max. Flow L/min (U.S.GPM)
MDS-01-* -30/3090	31.5 (4570)	35 (9.25)



Model Number Designation

F-	MDS	-01	-PA	-30	*
Special Seals	Series Number	Plate Size	Type of Detecting Line	Design Number	Design Standard
F: Special Seals for Phosphate Ester Type Fluids (Omit if not required)	MDS: Connecting Plate	01	PA: P&A-Lines PB: P&B-Lines AT: A&T-Lines	30	Refer to ★

★ Design Standards: None Japanese Standard "JIS" and European Design Standard
90 N. American Design Standard

Pressure Drop

Hydraulic Fluid: Viscosity 35 mm²/s (164 SSU),
Specific Gravity 0.850

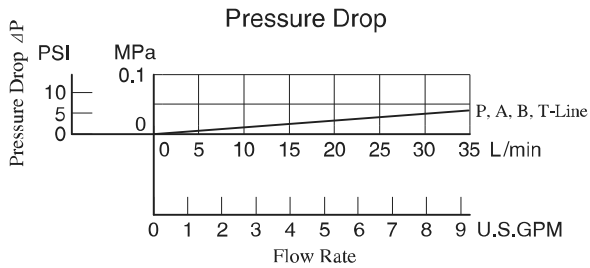

Graphic Symbols

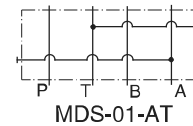
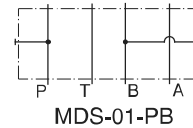
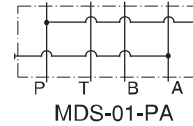

MDS-01-* -30/3090

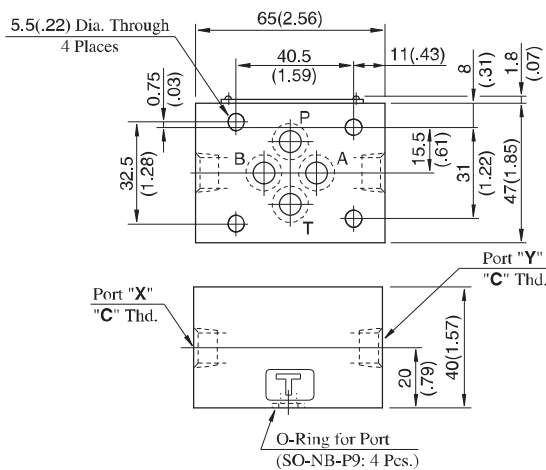

Approx. Mass.....0.8 kg (1.8 lbs.)

Model Numbers	Pressure Detecting Line	
	Port "X"	Port "Y"
MDS-01-PA	P-Line	A-Line
MDS-01-PB	B-Line	P-Line
MDS-01-AT	T-Line	A-Line

Model Numbers	Thread Size "C" Thd.
MDS-01-* -30	Rc 1/4 = 1/4 BSP.Tr
MDS-01-* -3090	1/4 NPT

DIMENSIONS IN MILLIMETRES (INCHES)

Base Plates For Modular Valves

Specifications

Max. Operating Pressure ----- 25 MPa (3630 PSI)



Model Number Designation

MMC	-01	-6	-40	*
Series Number	Plate Size	Number of Stations	Design Number	Design Standard
MMC: Base Plate	01	1: 1 Station	40	None: Japanese Standard "JIS" 80: European Design Standard 90: N.American Design Standard
		2: 2 Stations		
		3: 3 Stations		
		4: 4 Stations		
		5: 5 Stations		
		6: 6 Stations		
		7: 7 Stations		
		8: 8 Stations		
		9: 9 Stations		
		10: 10 Stations		

Pressure Drop

Hydraulic Fluid: Viscosity 35 mm²/s (164 SSU), Specific Gravity 0.850

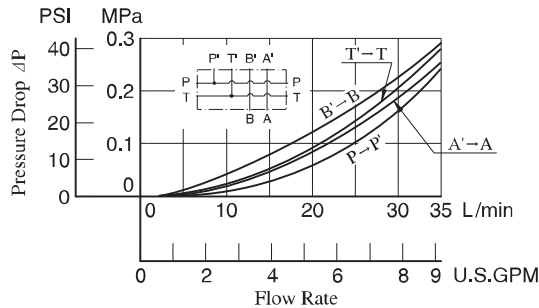

Graphic Symbols

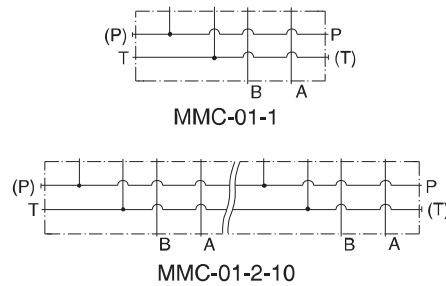

Instructions

- **Port Used:** Base plate has three (two, in case of 1 station type) **pressure port "P"**s and four **tank port "T"**s. Any one of these ports or two or more ports may be used. However, please note that the ports marked with (P) or (T) in the drawing are normally plugged. Remove the plugs when using such ports. Make sure that ports that are not currently used are properly plugged.

Interface Mounting Surface Dimensions for 1/8 Modular Valve

When standard base plates (MMC-01) are not used, the mounting surface described on right must be prepared. The mounting surface should have a good machined finish.

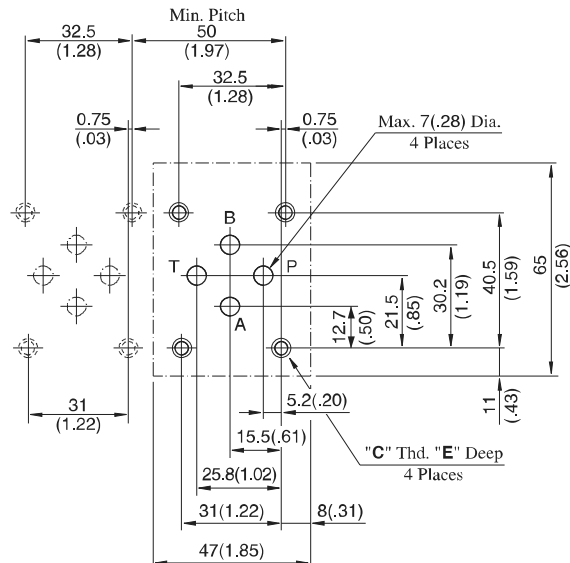

DIMENSIONS IN MILLIMETRES (INCHES)

Design Std.	"C" Thd.	E
Japanese Standard "JIS" and European Design Standard	M5	10 (.39)
N.American Design Standard	No. 10-24 UNC	12 (.47)

01 Series Modular Valves

MMC-01-1-40/4090

DIMENSIONS IN MILLIMETRES (INCHES)

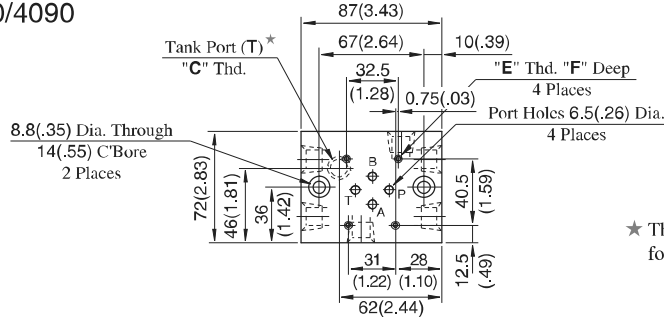

★ The two tank ports (T) are not machined for 4090 design.

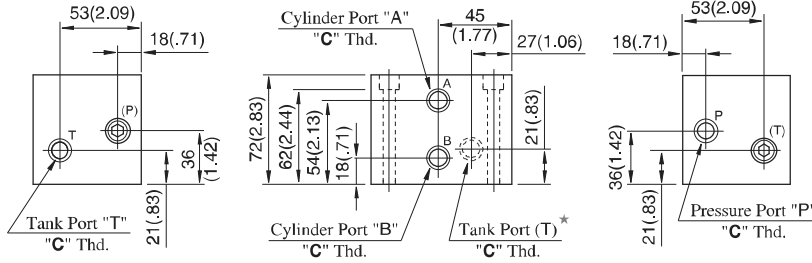

Approx. Mass : 3.5 kg (7.7 lbs.)

MMC-01-*40/4090

Number of Station (2-10 Stations)

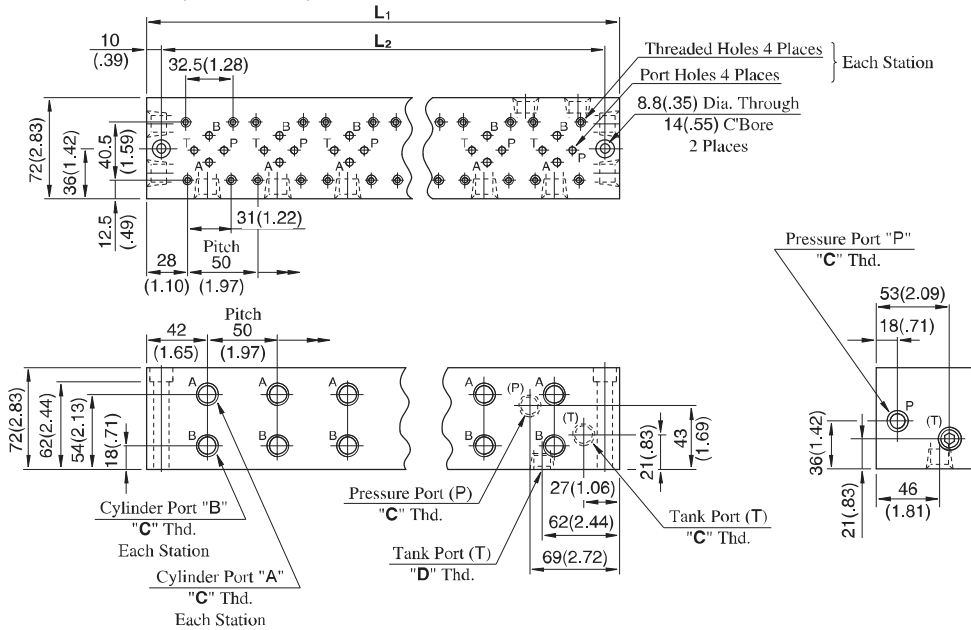

• For other dimensions, refer to above Model MMC-01-1.

Model Numbers	Thread Size			Dimensions mm (Inches)
	"C" Thd.	"D" Thd.	"E" Thd.	F
MMC-01-*40	Rc 3/8	Rc 1/2	M5	10 (.39)
MMC-01-*4090	3/8 NPT	1/2 NPT	No.10-24 UNC	12 (.47)

Model Numbers	Dimensions mm (Inches)		Approx. Mass kg (lbs.)	Model Numbers	Dimensions mm (Inches)		Approx. Mass kg (lbs.)
	L1	L2			L1	L2	
MMC-01-2	137 (5.39)	117 (4.61)	5.5 (12.1)	MMC-01-7	387 (15.24)	367 (14.45)	13.0 (28.7)
MMC-01-3	187 (7.36)	167 (6.57)	7.0 (15.4)	MMC-01-8	437 (17.20)	417 (16.42)	14.5 (32.0)
MMC-01-4	237 (9.33)	217 (8.54)	8.5 (18.7)	MMC-01-9	487 (19.17)	467 (18.39)	16.0 (35.3)
MMC-01-5	287 (11.30)	267 (10.51)	10.0 (22.1)	MMC-01-10	537 (21.14)	517 (20.35)	17.5 (38.6)
MMC-01-6	337 (13.27)	317 (12.48)	11.5 (25.4)				

MMC-01-1-4080

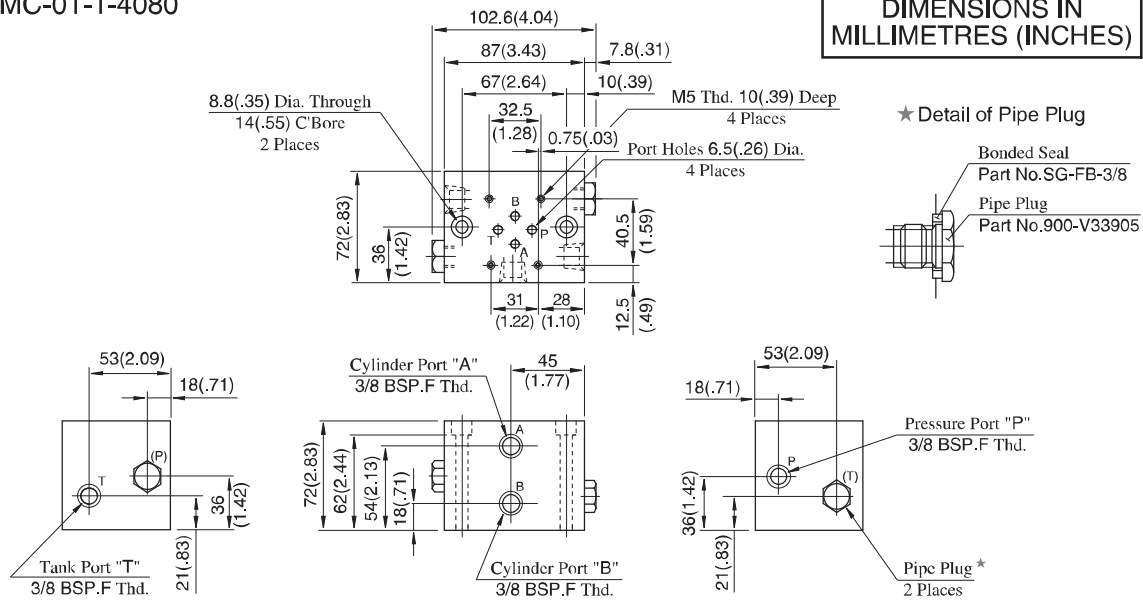

Approx. Mass : 3.5 kg (7.7 lbs.)

MMC-01-*-4080

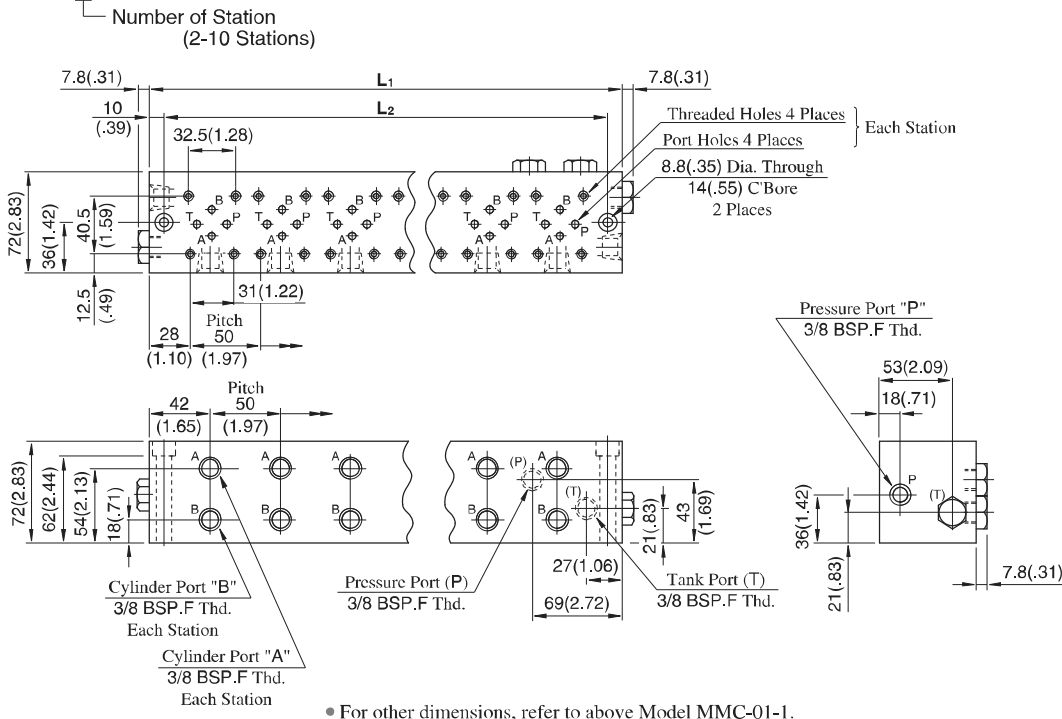

Model Numbers	Dimensions mm (Inches)		Approx. Mass kg (lbs.)	Model Numbers	Dimensions mm (Inches)		Approx. Mass kg (lbs.)
	L1	L2			L1	L2	
MMC-01-2	137 (5.39)	117 (4.61)	5.5 (12.1)	MMC-01-7	387 (15.24)	367 (14.45)	13.0 (28.7)
MMC-01-3	187 (7.36)	167 (6.57)	7.0 (15.4)	MMC-01-8	437 (17.20)	417 (16.42)	14.5 (32.0)
MMC-01-4	237 (9.33)	217 (8.54)	8.5 (18.7)	MMC-01-9	487 (19.17)	467 (18.39)	16.0 (35.3)
MMC-01-5	287 (11.30)	267 (10.51)	10.0 (22.1)	MMC-01-10	537 (21.14)	517 (20.35)	17.5 (38.6)
MMC-01-6	337 (13.27)	317 (12.48)	11.5 (25.4)				

F
01 Series Modular Valves

Mounting Bolt Kits

Valves are mounted with four stud bolts. Valve combination varies according to the circuit type. Hence, the mounting bolt kits are available on a combination type basis. When ordering the bolt kit, be sure to give the bolt kit model number from the table below.

Model Number Designation

MBK	-01	-02	-30	*
Series Number	Size of Modular Valve	Bolt Number	Design Number	Design Standard
MBK: Bolt Kits for Modular Valves	01	01, 02, 03, 04, 05 (Refer to the following chart)	30	Refer to ★

★ Design Standards: None Japanese Standard "JIS" and European Design Standard 90 N. American Design Standard

Bolt Kits Selection Chart

Model Numbers	Quantity of valves to be stacked			Approx. Mass g (lbs.)
	Solenoid Operated Directional Valve (*-DSG-01)	End Plate (MDC-01)	Modular Valve & Connecting Plate	
MBK-01-01-30*	1	0	1	60(.13)
	0	1		
MBK-01-02-30*	1	0	2	100(.22)
	0	1		
MBK-01-03-30*	1	0	3	130(.29)
	0	1		
MBK-01-04-30* ^{★1}	1	0	4	160(.35)
	0	1		
MBK-01-05-30*	1 ^{★2}	0	0	40(.09)
	0	1		

★ 1. In case of MBK-01-04-30*, operating pressure is restricted at 25 MPa (3630 PSI) or less.

★ 2. The solenoid operated directional valve comes with mounting bolts.

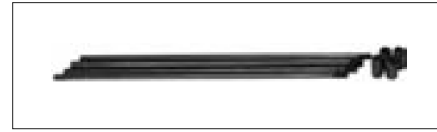

Bolt Kit Composition

Stud Bolt ----- 4 Pcs. } 1 Set
Nut ----- 4 Pcs. }

Note: In case of bolt kit model number having "05", four hexagon socket head cap screws only.

Tightening Torque:

Operating Pressure MPa (PSI)	Tightening Torque Nm (in. lbs.)
25(3630) or less	5 - 6 (44 - 53)
More Than 25(3630)	6 - 7 (53 - 62)

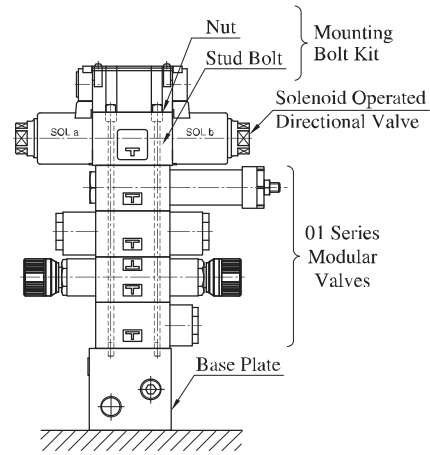

Stacking Example

MBK-01-01/02/03/04-30/3090

● Stud Bolt

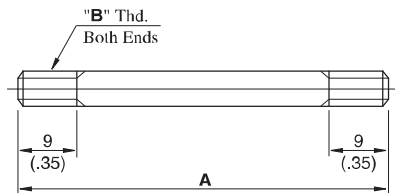

● Nut

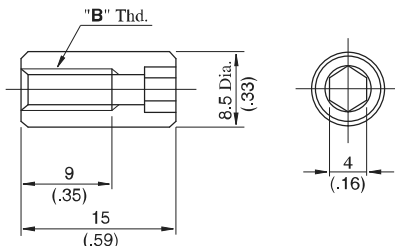

MBK-01-05-30/3090

● Socket Head Cap Screw

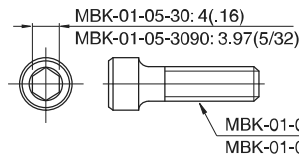

DIMENSIONS IN MILLIMETRES (INCHES)

Model Numbers	A mm (In.)	"B" Thd.
MBK-01-01-30	94 (3.70)	M5
MBK-01-02-30	134 (5.28)	
MBK-01-03-30	174 (6.85)	
MBK-01-04-30	214 (8.43)	
MBK-01-01-3090	94 (3.70)	No.10-24 UNC
MBK-01-02-3090	134 (5.28)	
MBK-01-03-3090	174 (6.85)	
MBK-01-04-3090	214 (8.43)	

3/8 Modular Valves

Type of Modular Valve

Class	Model Numbers	Graphic Symbols	Page	Class	Model Numbers	Graphic Symbols	Page	
Pressure Control Valves	Solenoid Operated Directional Valve (S)-DSG-03-***-50/5090 E-DSG-03-***-D*-50/5090 T-DSG-03-***-D24*-50/5090 G-DSG-03-***-50/5090		361 378 379 412	Flow Control Valves	Temperature Compensated Throttle and Check Valves (for "A&B-Lines", Metre-out) MSTW-03-X-20		595	
	Relief Valves (for "P-Line") MBP-03-**-30		578		Throttle Valves (for "P-Line") MSP-03-30		598	
	Relief Valves (for "A-Line") MBA-03-**-30		578		Check and Throttle Valves (for "P-Line") MSCP-03-20		600	
	Relief Valves (for "B-Line") MBB-03-**-30		578		Throttle and Check Valves (for "A-Line", Metre-out) MSA-03-X-40		602	
	Relief Valves (for "A&B-Lines") MBW-03-**-30		578		Throttle and Check Valves (for "A-Line", Metre-in) MSA-03-Y-40		602	
	Reducing Valves (for "P-Line") MRP-03-**-30/3090		581		Throttle and Check Valves (for "B-Line", Metre-out) MSB-03-X-40		602	
	Reducing Valves (for "A-Line") MRA-03-**-30/3090		581		Throttle and Check Valves (for "B-Line", Metre-in) MSB-03-Y-40		602	
	Reducing Valves (for "B-Line") MRB-03-**-30/3090		581		Throttle and Check Valves (for "A&B-Lines", Metre-out) MSW-03-X-40		602	
	Reducing Valves for Low Pressure Setting (for "P-Line") MRLP-03-10/1090		584		Throttle and Check Valves (for "A&B-Lines", Metre-in) MSW-03-Y-40		602	
	Reducing Valves for Low Pressure Setting (for "A-Line") MRLA-03-10/1090		584		Directional Control Valves	Check Valves (for "P-Line") MCP-03-**-10		605
	Reducing Valves for Low Pressure Setting (for "B-Line") MRLB-03-10/1090		584			Check Valves (for "A-Line") MCA-03-**-20		605
	Sequence Valves (for "P-Line") MHP-03-**-20		588			Check Valves (for "B-Line") MCB-03-**-20		605
	Counterbalance Valves (for "A-Line") MHA-03-**-20		588			Check Valves (for "T-Line") MCT-03-**-10		605
Counterbalance Valves (for "B-Line") MHB-03-**-20		588	Check Valves (for "P&T-Lines") MCPT-03-P*-T*-10			607		
Flow Control Valves	Flow Control Valves (for "P-Line") MFP-03-11		591	Anti-Cavitation Valves MAC-03-10			609	
	Flow Control and Check Valves (for "A-Line", Metre-out) MFA-03-X-11		591	Pilot Operated Check Valves (for "A-Line") MPA-03-**-20/2001			610	
	Flow Control and Check Valves (for "A-Line", Metre-in) MFA-03-Y-11		591	Pilot Operated Check Valves (for "B-Line") MPB-03-**-20/2001			610	
	Flow Control and Check Valves (for "B-Line", Metre-out) MFB-03-X-11		591	Pilot Operated Check Valves (for "A&B-Lines") MPW-03-**-20/2001			610	
	Flow Control and Check Valves (for "B-Line", Metre-in) MFB-03-Y-11		591	Modular Plates and Mounting Bolts		End Plates (Blocking Plates) MDC-03-A-10		613
	Flow Control and Check Valves (for "A&B-Lines", Metre-out) MFW-03-X-11		591		End Plates (Bypass Plates) MDC-03-B-10		613	
	Flow Control and Check Valves (for "A&B-Lines", Metre-in) MFW-03-Y-11		591		Connecting Plates MDS-03-10/1090		614	
	Temperature Compensated Throttle and Check Valves (for "A-Line", Metre-out) MSTA-03-X-20		595		Base Plates MMC-03-T-**-21/2180/2190		615	
	Temperature Compensated Throttle and Check Valves (for "B-Line", Metre-out) MSTB-03-X-20		595		Bolt Kits MBK-03-**-10/1090		618	

Relief Modular Valves

Specifications

Model Numbers	Max. Operating Pressure MPa (PSI)	Max. Flow L/min (U.S.GPM)
MBP-03-*-30 MBA-03-*-30 MBB-03-*-30 MBW-03-*-30	31.5 (4570)	70 (18.5)

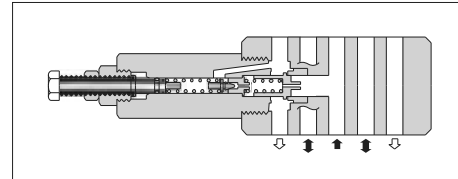

Model Number Designation

F-	MBA	-03	-B	-30	*
Special Seals	Series Number	Valve Size	Pres. Adj. Range MPa (PSI)	Design Number	Design Standard
F: Special Seals for Phosphate Ester Type Fluids (Omit if not required)	MBP : Relief Valve for P-Line MBA : Relief Valve for A-Line MBB : Relief Valve for B-Line MBW : Relief Valve for A&B-Lines	03	B : *-7 *1 (*-1020) H : 3.5-31.5 (510-4570)	30	Refer to ★ 2

★ 1. See the "Minimum Adjustment Pressure" of the next page for the item marked *.

★ 2. Design Standards: None Japanese Standard "JIS", European Design Standard and N. American Design Standard

Instructions

- The minimum adjustment pressure equals the value obtained from the minimum adjustment pressure characteristics plus the tank line back pressure of the next page. This back pressure should include the value of the T-line pressure drop characteristics of the valves stacked to the base plate side of the modular valve.
- To make pressure adjustment, loosen the lock nut and turn the pressure adjustment screw clockwise or anti-clockwise. For an increase of pressure, turn the screw clockwise. Be sure to re-tighten the lock nut firmly after making adjustment to the pressure.
- In case of a small flow, the setting pressure may become unstable. To avoid this, refer to the minimum flow characteristic curve of the next page and use the valve within a range as shown with .

Model Numbers	Graphic Symbols	Detailed Graphic Symbols
MBP-03		
MBA-03		
MBB-03		
MBW-03		

Typical Performance Characteristics

Hydraulic Fluid: Viscosity 35 mm²/s (164 SSU), Specific Gravity 0.850

Nominal Override Characteristics

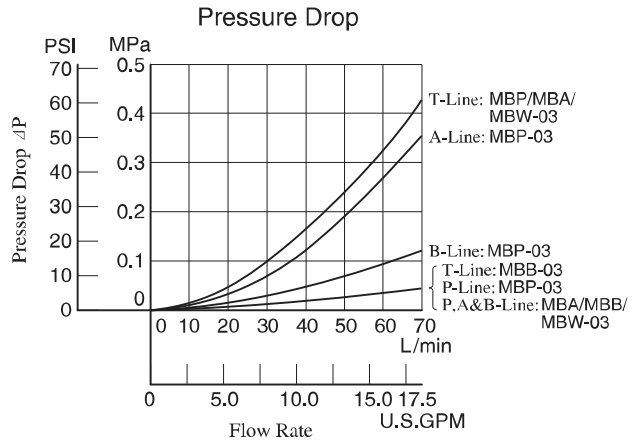
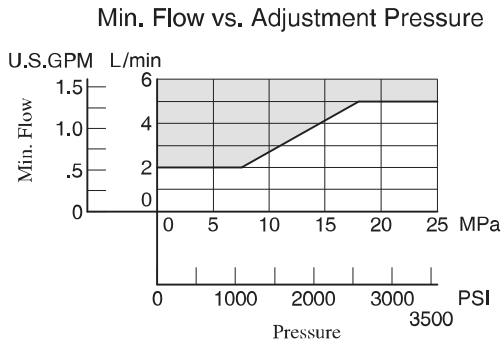
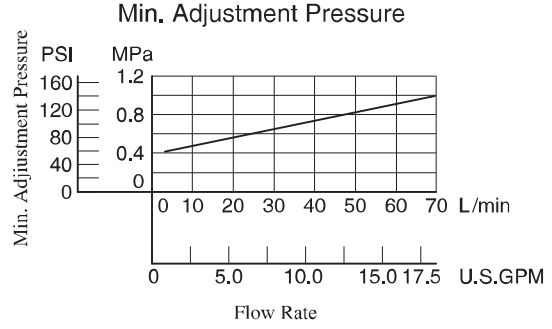
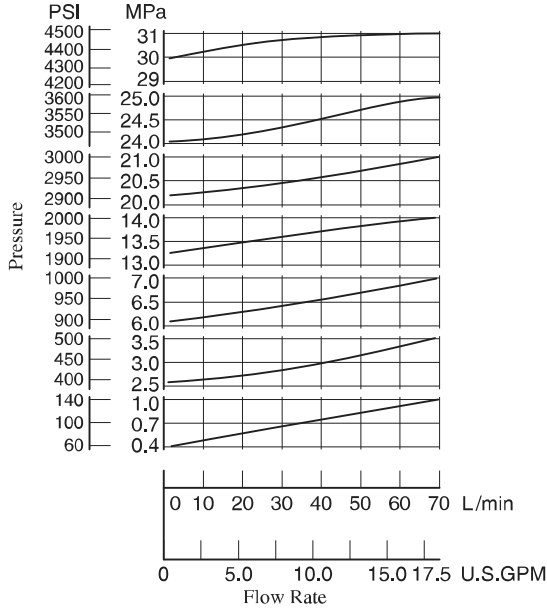

F

03 Series Modular Valves

MBW-03-*-30

DIMENSIONS IN MILLIMETRES (INCHES)

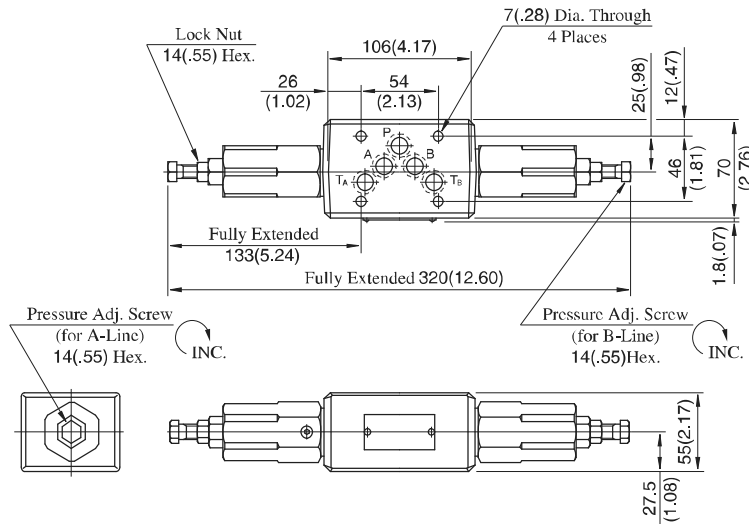

Approx. Mass.....3.8 kg (8.4 lbs.)

MBP-03-*-30
MBA-03-*-30

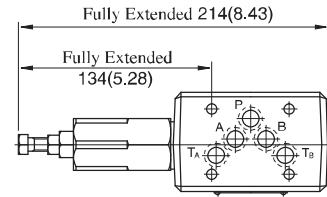

Approx. Mass.....3.1 kg (6.8 lbs.)

• For other dimensions, refer to "MBW-03" drawing left.

MBB-03-*-30

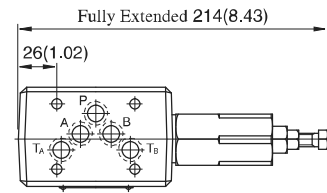

Approx. Mass.....3.1 kg (6.8 lbs.)

• For other dimensions, refer to "MBW-03" drawing left.

■ Spare Parts List

MBP-03-*-30
MBA-03-*-30

MBB-03-*-30

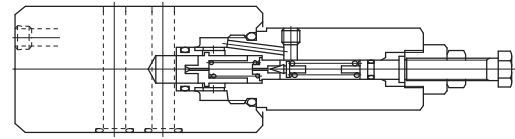
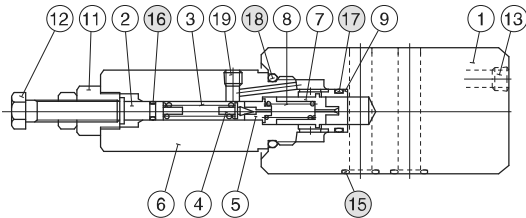

MBW-03-*-30

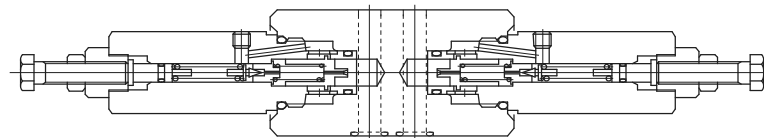

● List of Seals

Item	Name of Parts	Part Numbers	Quantity			
			MBP-03	MBA-03	MBB-03	MBW-03
15	O-Ring	SO-NB-A014	5	5	5	5
16	O-Ring	SO-NA-P6	1	1	1	2
17	O-Ring	SO-NB-P16	1	1	1	2
18	O-Ring	SO-NB-P26	1	1	1	2

Note: When ordering seals, please specify the seal kit number from the table right.

● List of Seal Kits

Valve Model Numbers	Seal kit Numbers
MBP-03	KS-MBP-03-30
MBA-03	
MBB-03	
MBW-03	KS-MBW-03-30

Reducing Modular Valves

Specifications

Model Numbers	Max. Operating Pressure MPa(PSI)	Max. Flow L/min (U.S.GPM)
MRP-03-*-30/3090 MRA-03-*-30/3090 MRB-03-*-30/3090	25 (3630)	70 (18.5) *

★ In pressure adjustment range "H", if the pressure in the primary side is set above 20 MPa (2900 PSI) and the pressure in the secondary side is set below 10 MPa (1450 PSI), the maximum flow is limited to 50 L/min (13.2 U.S.GPM).

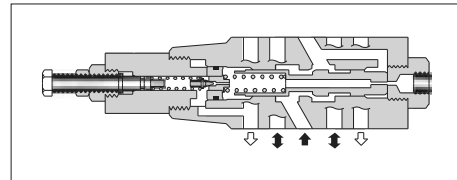
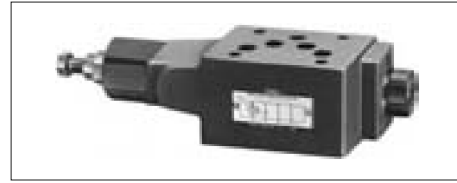

Model Number Designation

F-	MRP	-03	-B	-30	*
Special Seals	Series Number	Valve Size	Pres. Adj. Range MPa (PSI)	Design Number	Design Standard
F: Special Seals for Phosphate Ester Type Fluids (Omit if not required)	MRP : Reducing Valve for P-Line MRA : Reducing Valve for A-Line MRB : Reducing Valve for B-Line	03	B : 1-7 (145-1020) H : 3.5-24.5 (510-3550)	30	Refer to ★

★ Design Standards: None Japanese Standard "JIS" and European Design Standard
90 N. American Design Standard

Instructions

- The minimum adjustment pressure equals the lower limit of either pressure adjustment range (B, H) plus the tank line back pressure of the next page. This back pressure should include the value of the T-line pressure drop characteristics of the valves stacked to the base plate side of the modular valve.
- To make pressure adjustment, loosen the lock nut and turn the pressure adjustment screw clockwise or anti-clockwise. For an increase of pressure, turn the screw clockwise. Be sure to re-tighten the lock nut firmly after making adjustment to the pressure.

Model Numbers	Graphic Symbols	Detailed Graphic Symbols
MRP-03		
MRA-03		
MRB-03		



■ Typical Performance Characteristics

Hydraulic Fluid: Viscosity 35 mm²/s (164 SSU), Specific Gravity 0.850

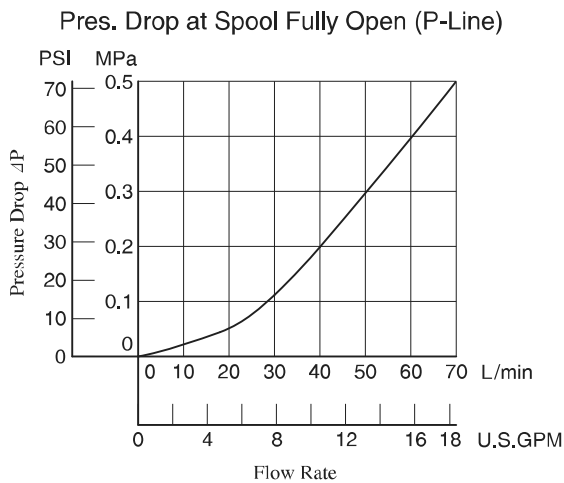
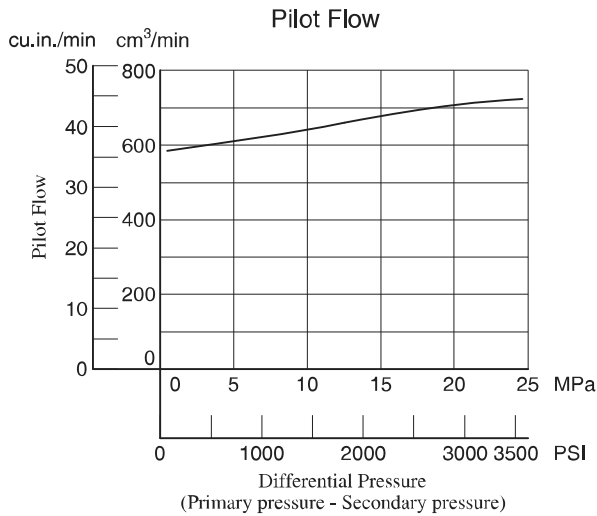
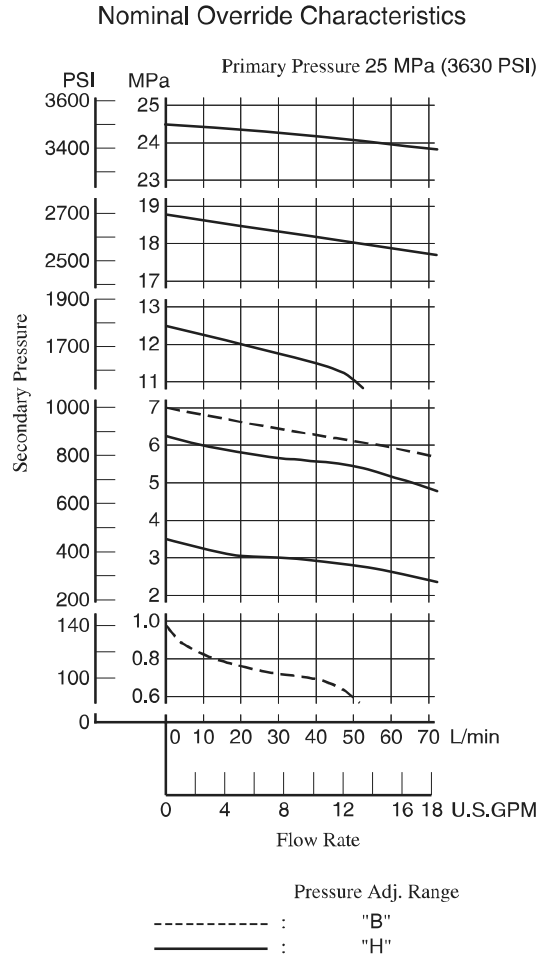
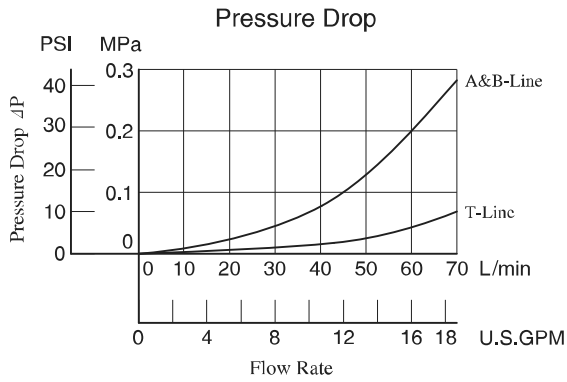

MRP-03-* -30/3090
MRB-03-* -30/3090

**DIMENSIONS IN
MILLIMETRES (INCHES)**

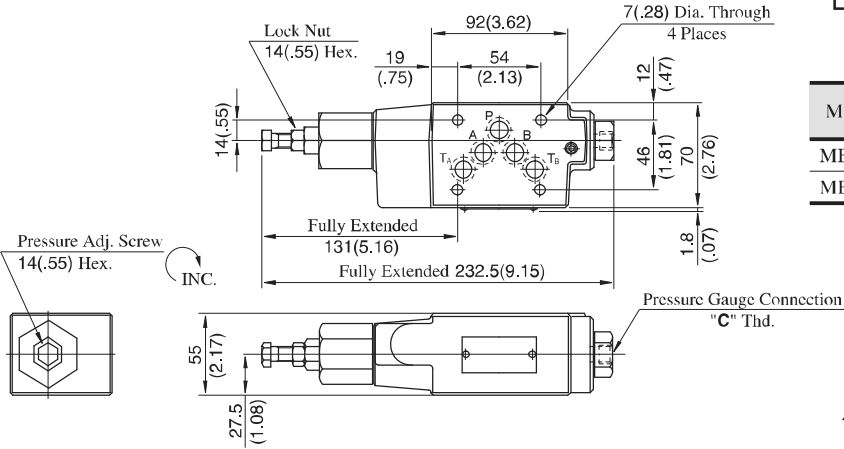

Model Numbers	Thread Size "C" Thd.
MB*-01-* -30	Rc 1/4 = 1/4 BSP.Tr
MB*-01-* -3090	1/4 NPT

Approx. Mass..... 3.3 kg (7.5 lbs.)

MRA-03-* -30/3090

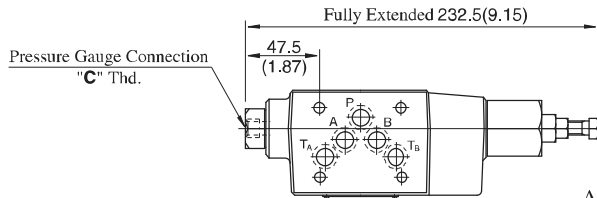

Approx. Mass..... 3.3 kg (7.5 lbs.)

• For other dimensions, refer to "MRP-03" drawing above.

■ Spare Parts List

MRP-03-* -30/3090

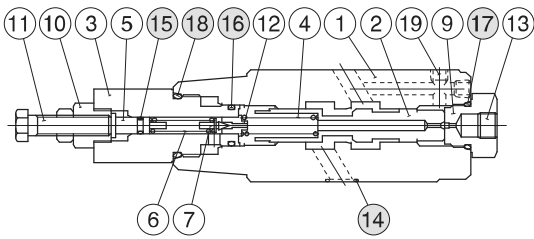

MRB-03-* -30/3090

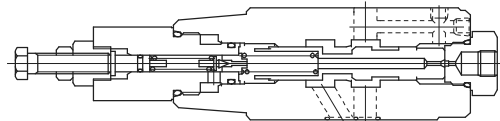

MRA-03-* -30/3090

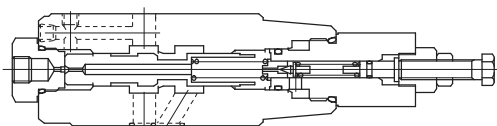

● List of Seals

Item	Name of Parts	Part Numbers	Qty.	Remarks
14	O-Ring	SO-NB-A014	5	Included in Seal Kit Kit No.: KS-MRP-03-30
15	O-Ring	SO-NA-P6	1	
16	O-Ring	SO-NB-P16	1	
17	O-Ring	SO-NB-P18	1	
18	O-Ring	SO-NB-P26	1	

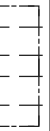

03 Series Modular Valves

■ Reducing Modular Valves For Low Pressure Setting

■ Specifications

Model Numbers	Max. Operating Pressure MPa (PSI)	Pres. Adj. Range MPa (PSI)	Max. Flow L/min (U.S.GPM)
MRLP-03-10/1080/1090 MRLA-03-10/1080/1090 MRLB-03-10/1080/1090	7 (1020)	0.2-6.5 (29-940)	50 (13.2) *

★ When pressure setting is less than 0.8 MPa (116 PSI), maximum flow decreases. See "Min. Adjustment Pressure vs. Max. Flow" on the next page for the appropriate range.

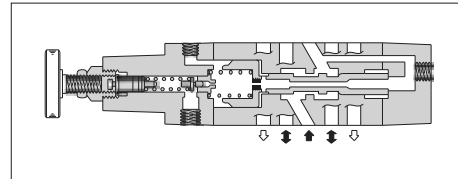
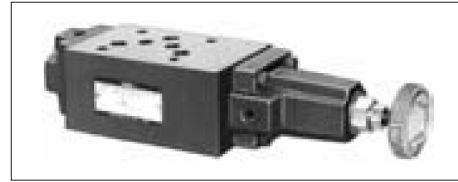

■ Model Number Designation

F-	MRLP	-03	-10	*
Special Seals	Series Number	Valve Size	Design Number	Design Standard
F: Special Seals for Phosphate Ester Type Fluids (Omit if not required)	MRLP : Low Pressure Setting Type Reducing Valve for P-Line MRLA : Low Pressure Setting Type Reducing Valve for A-Line MRLB : Low Pressure Setting Type Reducing Valve for B-Line	03	10	Refer to ★

★ Design Standards: None Japanese Standard "JIS"
80 European Design Standard
90 N. American Design Standard

■ Instructions

- If there is a pressure in drain line, it is added to the secondary setting pressure. Hence, drain line must be connected to tank directly with a low back pressure close to atmospheric pressure.
- To make pressure adjustment, loosen the lock nut and turn the pressure adjustment handle clockwise or anti-clockwise. For an increase of pressure, turn the handle clockwise. Be sure to re-tighten the lock nut firmly after making adjustment to the pressure.

Model Numbers	Graphic Symbols	Detailed Graphic Symbols
MRLP-03		
MRLA-03		
MRLB-03		

■ Typical Performance Characteristics

Hydraulic Fluid: Viscosity 35 mm²/s (164 SSU), Specific Gravity 0.850

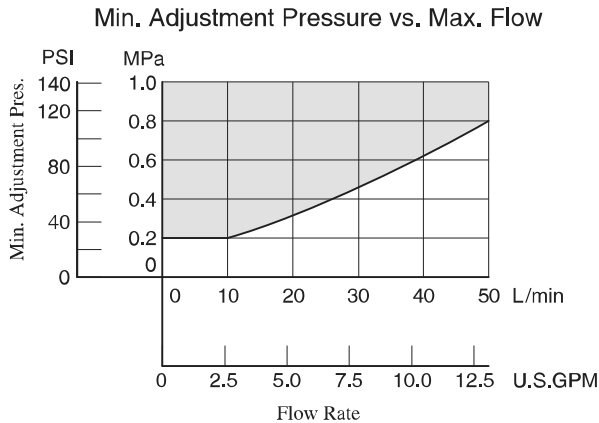
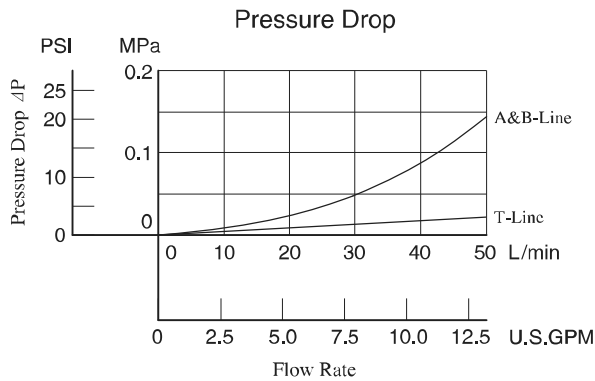
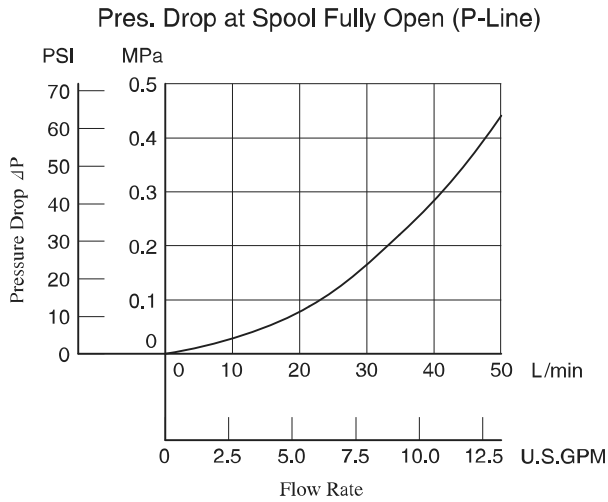

MRLP-03-10/1080/1090
MRLB-03-10/1080/1090

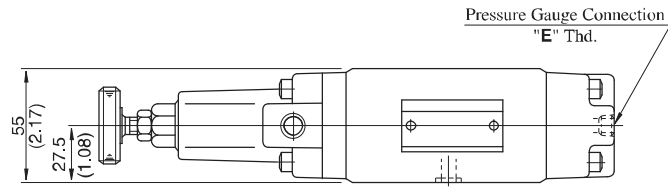
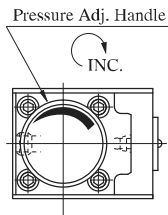
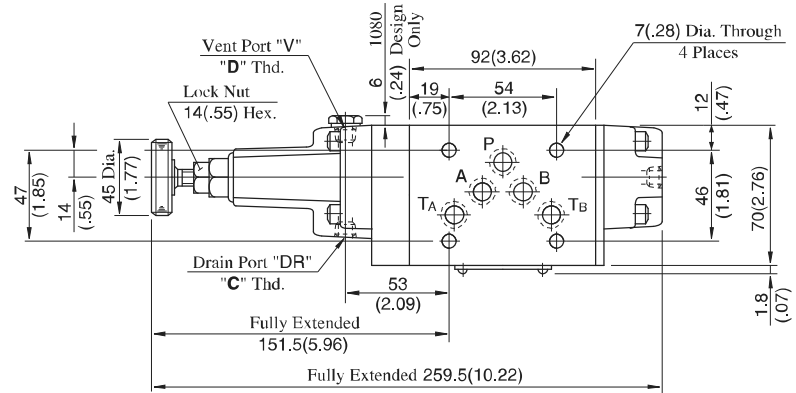

Approx. Mass..... 4.5 kg (9.9 lbs.)

Model Numbers	Thread Size		
	"C" Thd.	"D" Thd.	"E" Thd.
MRL*-03-10	Rc 1/4	Rc 1/8	Rc 1/4
MRL*-03-1080	1/4 BSP.F	1/8 BSP.F	1/4 BSP.Tr
MRL*-03-1090	1/4 NPT	1/8 NPT	1/4 NPT

DIMENSIONS IN MILLIMETRES (INCHES)

MRLA-03-10/1080/1090

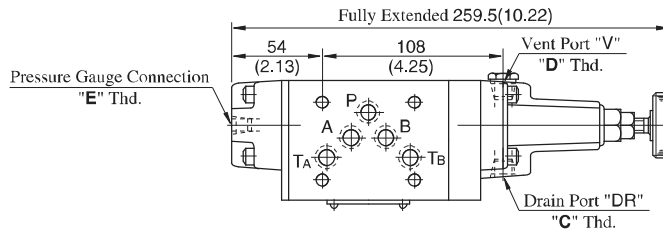

Approx. Mass..... 4.5 kg (9.9 lbs.)

• For other dimensions, refer to "MRLP-03" drawing above.

■ Spare Parts List

MRLP-03-10/1080/1090
 MRLB-03-10/1080/1090

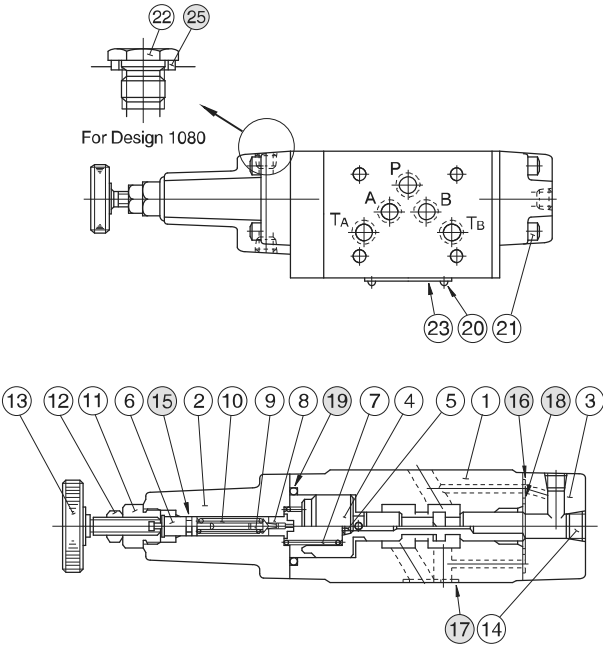

MRLA-03-10/1080/1090

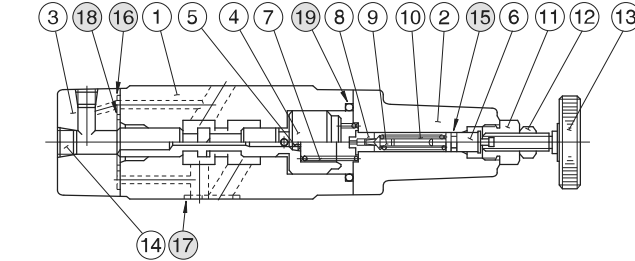

● List of Seals

Item	Name of Parts	Part Numbers	Qty.	Remarks
15	O-Ring	SO-NA-P6	1	Included in Seal Kit Kit No.:KS-MRLP-03-10
16	O-Ring	SO-NB-P6	2	
17	O-Ring	SO-NB-A014	5	
18	O-Ring	SO-NB-P22	1	
19	O-Ring	SO-NB-P32	1	
25	Bonded Seal	SG-FB-1/8	1	

Note: No bonded seal are included in seal kits.



Sequence Modular Valves/Counterbalance Modular Valves

Specifications

Model Numbers	Max. Operating Pressure MPa (PSI)	Max. Flow L/min (U.S.GPM)	Max. Free Flow L/min (U.S.GPM)
MHP-03-*-20	25 (3630)	50 (13.2)	—
MHA-03-*-20			70 (18.5)
MHB-03-*-20			70 (18.5)

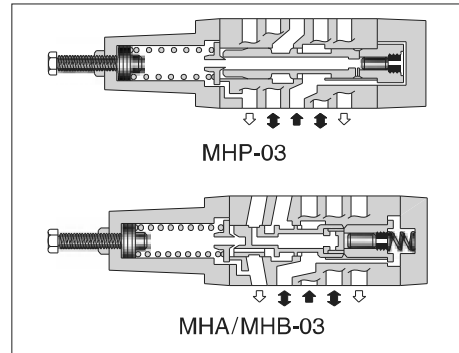
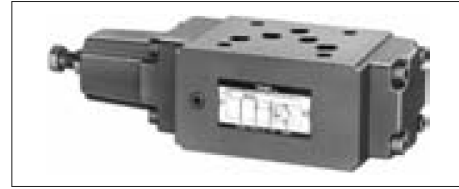

Model Number Designation

F-	MHA	-03	-C	-20	*
Special Seals	Series Number	Valve Size	Pres. Adj. Range MPa (PSI)	Design Number	Design Standard
F: Special Seals for Phosphate Ester Type Fluids (Omit if not required)	MHP: Sequence Valve for P-Line	03	N: *-1.8 (*-260) *1 A: 1.8-3.5 (260-510) B: 3.5-7 (510-1020) C: 7-14 (1020-2030)	20	Refer to ★ 2
	MHA: Counterbalance Valve for A-Line MHB: Counterbalance Valve for B-Line			20	

★ 1. See the "Minimum Adjustment Pressure" of the next page for the item marked *.

★ 2. Design Standards: None Japanese Standard "JIS", European Design Standard and N. American Design Standard

Instructions

- The minimum adjustment pressure equals the value obtained from the minimum adjustment pressure characteristics plus the tank line back pressure of the next page. This back pressure should include the value of the T-line pressure drop characteristics of the valves stacked to the base plate side of the modular valve.
- To make pressure adjustment, loosen the lock nut and turn the pressure adjustment screw clockwise or anti-clockwise. For an increase of pressure, turn the screw clockwise. Be sure to re-tighten the lock nut firmly after making adjustment to the pressure.

Model Numbers	Graphic Symbols	Detailed Graphic Symbols
MHP-03		
MHA-03		
MHB-03		